

# Textbook of Plumbing and Solar Water Heating System-I

## Matric Tech Grade IX

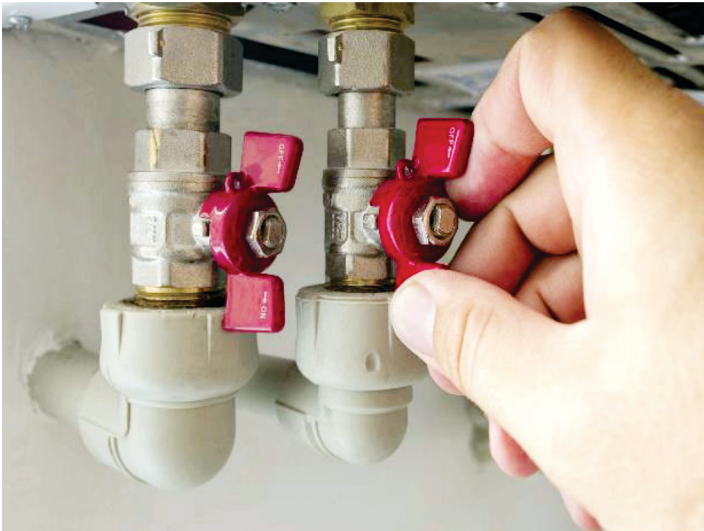

National Vocational & Technical Training Commission (NAVTTTC)

**Textbook of**  
**Plumbing and Solar Water Heating System-I**  
**For Matric Tech GRADE-IX**



**GOVERNMENT OF PAKISTAN**  
**Ministry of Federal Education and Professional Training**  
**ISLAMABAD**  
**In Collaboration with**  
**National Vocational and Technical Training Commission**

**Author:** Imtiaz Ahmad Awan, Senior Instructor, Govt. College of Technology Rasul

- Reviewers:**
1. Mr. Muhammad Nasir Khan, DACUM Facilitator
  2. Engr. Azhar Iqbal Shad, Principal, Govt. College of Technology Raiwind Road, Lahore
  3. Mr. Javed Sarwar, Assistant Controller of Examination (Schools) AJK Board of Intermediate & Secondary Education, Mirpur.
  4. Mr. Tahir Mehmood, Assistant Professor, Federal College of Education, H-9, Islamabad
  5. Mr. Muhammad Amjad Rafique, Principal, Govt. College of Technology Rasul
  6. Engr. Rebab Maria Mehmood, Site Engineer, JMC, Lahore
  7. Mr. Adnan Shoukat, Instructor Foundation Institute of Technology, Rawalpindi
  8. Engr. Arsalan Hameed Khan, Associate Officer, Planning Department, Lahore
  9. Ms. Abida Munir, Education Officer, National Curriculum Council (NCC), Islamabad
  10. Mr. Muhammad Asim Khan, Assistant Director, NAVTTC, Islamabad
  11. Mr. Inam ul Haq, Instructor, CTTI, Islamabad

**Designing:** Gul Awan Printers, Blue Area, Islamabad.

**Edition:** 1<sup>st</sup> Edition, 2022

**ISBN:**

**Publishers:** National Vocational & Technical Training Commission  
H-9, Islamabad.  
Website: [www.navttc.gov.pk](http://www.navttc.gov.pk),

All rights are preserved with the National Vocational and Technical Training Commission. No part of this book can be copied, translated, reproduced or used for guide books, key notes, helping books etc. without permission of NAVTTC.

**Note:** Names of Curriculum Developers will be part of curriculum document. In the book there will be names of reviewers only.

## PREFACE

Any building however costly, without a proper plumbing system, is only a skeleton. Proper plumbing alone adds life to the building and the inhabitants. Hence proper plumbing system as per the code of practices with the correct specifications of materials like pipes and fixtures should be used to make buildings sustainable.

This book has been written to meet the requirements to train the students of Matric Tech in plumbing. Matric Tech in plumbing has been introduced the first time in the history of Pakistan. This textbook is the first national effort to describe the topics related to plumbing and solar water heating system in one book. The book covers 40% theory and 60% practical content. These contents are equally helpful for the students of various plumbing systems.

A key attempt has been made to make the book interesting and useful. All the chapters cover the basic details understandable to the students of secondary school level. All chapters include relevant plumbing activities and also assessments in form of MCQs, short questions, and long questions.

Suggestions from the teachers/ instructors as well as students from the different institutions for the improvement of this book would be appreciated and welcomed with thanks.

**Executive Director  
National Vocational & Technical Training Commission  
(NAVTTTC)**

## **TABLE OF CONTENTS**

<b>S.No</b>	<b>Title</b>	<b>Page#</b>
1	Introduction to Plumbing	1
2	Occupational Health & Safety	17
3	Plumbing Tools and Equipments	35
4	Measuring, Marking and filing	57
5	Cutting and Drilling	73
6	Threading and Drilling	82
7	Communication Skills	93
	Glossary	110
	Answers to Multiple Choice Questions	118
	Bibliography	119

# CHAPTER 1

## INTRODUCTION TO PLUMBING



### **Students' Learning Outcome**

**After studying this chapter students will be able to:**

- know the basics of plumbing.
- state consideration during plumbing.
- purposes of plumbing.
- importance of plumbing.
- scope of plumbing.
- recognition of main fixtures of plumbing.
- recognition of ppes for workplace.
- classification of plumbing
- state the types of plumbing
- understand sections of plumbing system.

## **1 Introduction.**

We need fresh water for drinking, cooking foods, taking bath, washing clothes & utensils, and for other purposes. We also require the drainage/ disposal of used waste water. The two systems which serve the purpose are known as plumbing systems. Hence plumbing system is the network of pipes for supply of fresh water and disposal of waste water along with its fixtures, appliances and appurtenances. The two systems should not intersect to avoid contamination. A good plumbing system takes clean water in and forces out waste water. Any sign that water is not draining correctly is generally an indicator of a problem in the system.

### **1.1 Basics of Plumbing**

A plumbing system is network of pipes along with fixtures and appliances. It is needed to run water i.e., potable water supply which deals with fresh water, and the disposal of waste water.

#### **1.1.1 Potable Water Supply**

The very first system in our homes, controls the inflow of water as well as provides us with clean water. The plumbing components which are connected to our potable supply of water are fixtures, appurtenances and appliances. The components of water supply which are used to connect two or more pipes, change the direction of flow, etc. are called fittings, e.g., socket, elbow, bend, union, cross, etc.

The different devices required for controlling the flow of water, for preventing leakage and for other purposes in the water supply system are called appurtenances. For example, valves, cocks, fire hydrants. Valves are the mechanical devices that control the flow of water, regulate pressure, to release or admit air, and prevent flow of water in opposite direction. Types are gate valve, globe valve, swing check valve, lift check valve, tilting-disc check valve, folding-disc check valve, in-line check valve, stop check valve, ball valve, pinch valve, butterfly valve, plug valve, diaphragm valve, safety valve, relief valve. Some appliances which perform specific functions are showers, dishwasher, water meter, hot water heater, etc.

#### **1.1.2 Sanitary System**

Likewise, the water supply system it is also a network of pipes, but it is meant for disposal of waste water and foul gases. The used water goes down through the drainpipe and enter into sanitary plumbing system. Drain pipes feed used water right into outward bound pipelines that transport the waste water into sewer or septic tanks. Urban and rural have drain systems to manage the drainage, as well as country residences have septic systems for cleanliness. Some examples for sanitary system for fixtures are wash hand basin, water closet, bathtubs, traps, and vents.

## **1.2 Consideration during plumbing.**

The followings should be considered for a plumbing system.

- 1- Size of pipe for flow of water.
- 2- Proper slope in disposal pipe for gravity flow. Usually  $\frac{1}{4}$ " for each foot length (1:48).
- 3- Open or concealed pipes
- 4- Invert level of main and branch pipelines for drainage to ensure sufficient fall.

- 5- Centre to centre spacing of manhole according to size of pipes.
- 6- Length of unvented disposal pipe.
- 7- Proper sealing of joints.
- 8- Proper hole in building structural members for pipes.
- 9- Location of appliance right above disposal intake.
- 10- Location of Concealed pipe in floors and walls to avoid displacement in future.
- 11- Proper location of gully traps
- 12- Proper level of gully traps
- 13- Proper height of vent pipes

### 1.3 Purposes of plumbing.

The main purpose of the plumbing system is to deliver clean water in every residential and commercial building and, at the same time, eliminate all waste water. These two factors will work side-by-side to bring comfort and safety to everyone's health. Plumbing systems also serve the following purposes:

- Effectively deliver clean and drinkable water to regions those are affected by water shortage.
- Promote the use of water efficiently by use of pressure reducing valve, resulting less use of water in bath, kitchen and other parts of building.
- Effectively conserve energy, by use of less water, the amount of water needed to heat, and transport will lessen as well.

Do you know?

The three roles of a competent plumber are:

1. To design, install and maintain water supply and waste removal systems;
2. To manage health risk and cost associated with plumbing;
3. To help conserve water.

### 1.4 Importance of plumbing.

- Plumbing makes it possible for provision of clean and drinkable water.
- By use of plumbing fixtures, we control the flow of water as per need. This will lead to the saving of water and subsequently money is saved.
- For the safety of building, a good plumbing system prevents from danger of leakage in the building which can destroy the building. The leakage may also affect health by contamination in still water by bacteria and other dangerous germs etc.
- Hot water heaters are important for the building for comfort. Solar energy is utilized which results in saving money. These are achieved by proper plumbing system.



- Water purification is also important for health. Public water is run through a purification system before it is distributed to public.
- By plumbing, waste water from all sources is disposed off.
- Treatment of waste water for recycling is dependent over good plumbing system.
- Foul gases are disposed high above the living level.

Do you know?

Any building however costly, without proper plumbing system, is only a skeleton. Proper plumbing alone adds life to the building. Hence proper plumbing system as per the code of practices with the correct specifications of materials like pipes and fixtures should be used to make buildings sustainable.

### 1.5 Scope of plumbing.

The scope of standard residential plumbing usually covers mains pressure, potable water, heated water (in conjunction with mechanical and/or electrical engineers), sewerage, storm water, natural gas, and sometimes rainwater collection and storage. In commercial environments, these distribution systems expand to accommodate many more users, as well as the addition of other plumbing services such as irrigation, fuels, oxygen, vacuum/compressed air, solids transfer, and more. Plumbing systems also service air distribution/ control, and therefore contribute to the mechanical part of Mechanical Electrical Plumbing (MEP). Plumbing for Heating, Ventilating & Air Conditioning (HVAC) system involves the transfer of coolant, pressurized air, water, and occasionally other substances. Ducting for air transfer may also be considered plumbing, but is generally installed by different trades people.

### 1.6 Recognition of main fixtures of plumbing.

In general plumbing terms, a plumbing fixture can be any device that is connected to a plumbing system and interacts with water (whether it be delivering the water or draining it).

#### Water closet (W.C.)

Water closet is a sanitary fixture which disposes human excretion through sanitary system. It is usually manufactured from China clay duly glazed. Other material is terrazzo. These are of two types:

- i- European type,
- ii- Indian type



*English water closet*



*Indian water closet*





## Wash hand basin(WB)

Wash hand basin (WB) is used to wash hand and mouth. It is usually manufactured from China clay duly glazed. Other materials are terrazzo, stainless steel, iron duly painted etc. Needless to say, various types of basins cater to different needs. There are above counter basins, under-mount basins, compact basins, wall-hung basins, corner type basin, bowl type basin and a lot more.

			
<i>Basin with two taps</i>	<i>Corner type Basin</i>	<i>Basin with mixer</i>	<i>Bowl type basin</i>

## Traps

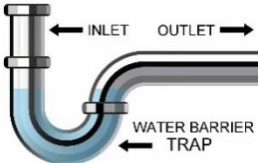
Traps are used to block movement of foul gases back to home with the help of water seal (barrier). Gully trap is fixed in courtyard. Floor trap in bath, P-Trap are used with Indian WC, pipe p-traps are fixed with waste pipe of sink & wash basin, S or V-Trap with English WC.

			
			<i>Gully Trap (GT)</i>
			
<i>Floor Trap (FT)</i>	<i>P-Trap for Basin (PT)</i>	<i>V-Trap (VT)</i>	<i>P-Trap (PT)</i>

## Urinal: (U)

A urinal is a sanitary plumbing fixture for urination only used usually in public toilets for male users in Western countries (less so in Muslim countries). They are usually used in a standing position. Urinals can be with manual flushing, automatic flushing, or without flushing, as is the case for waterless urinals. They can be arranged as single sanitary fixtures (with or without privacy walls) or in a trough design without privacy walls. Urinals designed for females ("female urinals") also exist but are rare. It is possible for females to use male urinals with a female urination device. These may be wall type, stand type, or corner type.



Urinal

**Flushing Cistern (FC):**

A flushing cistern includes a reservoir with an outlet opening, the opening and closing of which is controlled by a cistern bell. Its sizes are one-to-3-gallon capacity. F.C. is used to flush waste in WCs and urinals to sanitary pipe work. Water-closet flushing cistern are of three main types-the valve, the siphon, pneumatic and the tipper.



*Flushing cistern*

<p><b>Sink and its Mixer:</b> Sink is used in kitchen to wash utensils. For cold and hot water system, sink mixer is used to mix and supply water at required temperature (not more than 38°C)</p>		
	<p>Kitchen Sink</p>	<p>C.P. Sink Mixer</p>

<p><b>Bathtub and its Mixer:</b> Bathtub is used in bathroom for taking a bath. For cold and hot water system, bathtub mixer is used to mix and supply water at required temperature (not more than 38°C)</p>		
	<p><i>Bathtub (BT)</i></p>	<p><i>C.P. Bath Tub Mixer</i></p>
<p><b>Water heater/ Geyser:</b> Water heaters are used to heat water. They may be in the form of Gas geyser, electric geyser, instant gas/ electric geyser and solar water heaters etc.</p>		
	<p><i>Instant Geyser</i></p>	<p><i>Gas Geyser</i></p>
<p><b>Shower rose and its Mixer:</b> Shower rose serve the purpose of taking a bath in bathroom. For cold and hot water system, shower mixer is used to mix and supply water at required temperature (not more than 38°C)</p>		
	<p><i>C.P. Shower Rose</i></p>	<p><i>C.P. Shower Mixer</i></p>

## Showers









Showers are fundamentally a very simple appliance designed to contain water for a person or two and to drain spent water into the sewer system.

## Valves, Taps and Cocks

**Valves** are the mechanical devices that control the flow of water, regulate pressure, to release or admit air, prevent flow of water in opposite direction. These are ferrule valve, ball valve, gate valve, globe valve, check valve, non-return valve, air release valve, sluice valve, float valve etc.

**Taps** also give us fresh water with required discharge.

**Cocks** also regulate the flow of water between two pipes or between exit from fresh water and entry to a sanitary fixture. Stop cock, Tee stop cock, bib cock, pillar cock, etc.

			
Ball Valve (BV)	Gate valve (GV)	Temperature control valve (TCV)	Ferrule valve (FV)
			
Stop Cock (SC)	Tee Stop Cock (TSC)	Bib-Cock (BC)	Air Release valve (ARV)

### 1.7 Recognition of Personal Protective Equipments (PPEs)

Personal protective equipments are necessary for the safety of all the workforce employed at the workplace. It is the slogan of workplace the “Safety First”.

#### 1.7.1 Types of Personal Protective Equipment

Personal protective equipments are made for different parts of human body to protect each from suspected type of hazard. So those are classified according to the part of human body as given below:

### i. Head protection

Specific nature head protection equipments are hard hat, bump caps, helmets, head guards & accessories. These prevent the workers from injury that may occur due to fall of anything or the fall of worker himself.

			
hard hat and bump caps	helmet	Head guard Leather	head gear





### ii. Hand protection



For the safety of hands, hand protection specific nature gloves are used, e.g., work gloves are for general work and thermal gloves are used to work with hot objects. Similarly chemical gloves are for working with chemical nature job and mechanical gloves are used mechanical nature jobs i.e., hitting hammers to the workpiece.

			
hand work gloves	thermal gloves	chemical gloves	mechanical gloves

### iii. Eye and face protection

Different types of eye wears are used for protection of eyes. The safety glasses & eye shields protect eyes from light rays. Over specs prevent the eyes from harm of surrounding liquids, chemicals due flow in to eyes. Face visors, eye wear accessories, face shields, safety goggles are also used for protection of face and eyes. Face masks prevent face from dust/ virus inhaling.

			
safety glasses	eye shield	over specs	eye wear accessory

		
safety goggles	face shield	face visor

**iv. Breathing apparatus**

For working in a place where natural free oxygen is not available in the atmosphere, breathing escape set & breathing vents are used

	
breathing escape set	Breathing vent

**v. Protective clothing**

Dress worn at work place for different nature hazards. These are chemical clothing, hi-visibility clothing, Ferro-Electric (FE) clothing, weather wear, workwear, overall and dangri,

			
chemical clothing	Hi-Visibility Dress	FE Clothing	Weather Wear

**vi. Foot protection**

These prevent from getting foot injuries due to slippery surface, heavy falling or rolling objects, sharp piercing edges, pinch points, etc. Safety footwear, long shoes, Electrostatic Dissipative (ESD) footwear.

	
Safety footwear	Long shoes

**vii. Hearing protection**



These are used for the protection of ears. Ear defenders, ear plugs, communications sets, noise meters, acoustic foam.

### viii. Respiratory protection

These are used for the protection of respiratory system. For example filter respirators, masks, powered respirators, detectors and monitors.

### ix. Fall management equipment

Various arrangements are made to protect from falling. These may include: fall arresters, elbow and wrist supports, safety rope climbing, safety belt, scaffold, full body belt Back supports, safety railing, etc.

<p><b>Safety rope climbing:</b> Safety ropes are use to climb up. So, worker have support from falling.</p> <p><b>Safety belts</b> Safety belts of full body, back body belts are used to work without fear of falling</p>	 <p>safety rope climbing</p>	 <p>Safety belt</p>
--	--	--

### Activity-1.1: Recognition of existing fixtures.

The teacher/ instructor is required to direct the students for recognition of different fixtures in the school building in various rooms. The students have to prepare the list of appliances and fixtures installed in each type of room.

Students shall also prepare the list of personal protective equipments and dresses for the installation of different types of fixtures.

## 1.8 Classification of Plumbing

Plumbing is classified for the purpose which is required to be achieved. These are detailed as given below.

1. Potable Cold and Hot Water Supply
2. Drainage Venting Plumbing.
3. Septic System.
4. Fuel Gas Piping.

### 1.8.1 Potable Cold and Hot Water Supply

It is one of the basic plumbing systems around a house. Under this type of plumbing system, cold and hot water flows through all faucets in the home. The plumbing system allows the passage of hot water and the water is heated on the way to the tap.

It has been seen that most of the houses in urban areas have this type of plumbing system. The portable cold and hot water supply plumbing system is installed in the back yard of the house close to the exterior of the bathroom.

### **1.8.2 Septic System**

It is a small and independent septic system where the sewage water is dumped. In some under developed areas, it has been seen that residential complexes are not connected to the sewage system. In such cases, people need to contact professional plumbers for septic system.

The septic system is made up of components including septic tanks, drainage area for dumping the sewage and soakage pit. However, the septic tank needs to be cleared and treated for odour at regular interval of time. Most of the population in country area uses septic plumbing system.

### **1.8.3 Fuel Gas Piping**

Fuel gas piping is the plumbing system which facilitates the supply of fuel gas for stoves geysers, lanterns and for other purposes. It is the most common *type of plumbing system* after potable water system plumbing and drainage venting plumbing.

Gas as a fuel is highly inflammable due to which proper construction, repair, renovation and maintenance of gas fuel pipes are required. The specialized plumbers are available to handle fuel gas piping in a building.

Plumbing system is known to be the circulating system of the house. The plumbing pipes are embedded in the floor and behind the door which carries the sewage water silently outside the house and dumps it into a main drainage pipe in the city.

### **1.8.4 Drainage & Venting Plumbing**

Drainage venting is one of the most common types of plumbing systems in commercial buildings, residential houses and industrial units. Drainage venting plumbing system allows the outflow of all the sewage and grey water from the building through the designated pipes.

This type of plumbing system also allows the exit of trapped air in sewage pipes. It has been noted that failure in the plumbing system often leads to accumulation of sewage water and odour.

To avoid such problems, the plumbing system is checked by the professionals. The designated pipes in the building for the passage of sewage water is connected with a main drainage pipe of the city that leads the grey water to sewage treatment plant.

## **1.9 Sections of Plumbing System.**

The Plumbing system is network of pipes duly jointed & also jointed with subsystems, fixtures and parts. These parts work together to make the system effective. There are five basic components of the plumbing systems in use today. These include the pipes, pipe fittings, fixtures, Appliances and Appurtenances. If any of these components fail, the entire system fails and needs to be inspected by a skilled professional.



### **1.9.1 Pipelines (Pipe and Pipe Fittings)**

Pipes are used to convey liquids and gases. Different pieces of pipes are interconnected with fittings. The main liquids in plumbing are fresh drinking water, waste water from residential, commercial buildings, industrial waste water, rainwater, oils etc .Pipelines with potable water are called fresh water pipelines. For disposal, pipelines are called sewer lines. For disposal of foul gases pipe is called vent pipe or a big one as vent shaft. For conveyance gas a gas line and for oils oil pipeline.

Examples of fittings are socket, tee, elbow, bend, union, bush etc.

### **1.9.2 Plumbing Fixtures**

Fixture is a device that is connected to a water supply system or discharges to a drainage system or both. Such receptacles or devices require a supply of water; or discharge liquid waste or liquid-borne solid waste; or require a supply of water and discharge waste to a drainage system. Examples of a plumbing fixture would be a sink, wash hand basin, toilet, and bathtub.

### **1.9.3 Plumbing Appliances**

Appliances are water-connected or drain-connected devices intended to perform a special function. These devices have their operation or control dependent on one or more energized components, such as motors, controls, or heating elements. Such devices are manually adjusted or controlled by the owner or operator, or are operated automatically through one or more actions, like time cycle, temperature range, pressure range, measured volume or weight.

Examples of a plumbing appliances would be washing machine, dishwasher, and water heater.

### **1.9.4 Plumbing Appurtenances**

Appurtenance is a manufactured device, prefabricated assembly or an on-the-job assembly of component parts that is an assistant to the basic piping system and plumbing fixtures. An appurtenance demands no additional water supply and does not add any discharge load to a fixture or to the drainage system. Examples of plumbing appurtenance are a water meter, pressure gauge, vacuum breaker and pressure reducing valve.

Understanding the difference between them is necessary for applying the building code requirements for each category to specific plumbing devices.

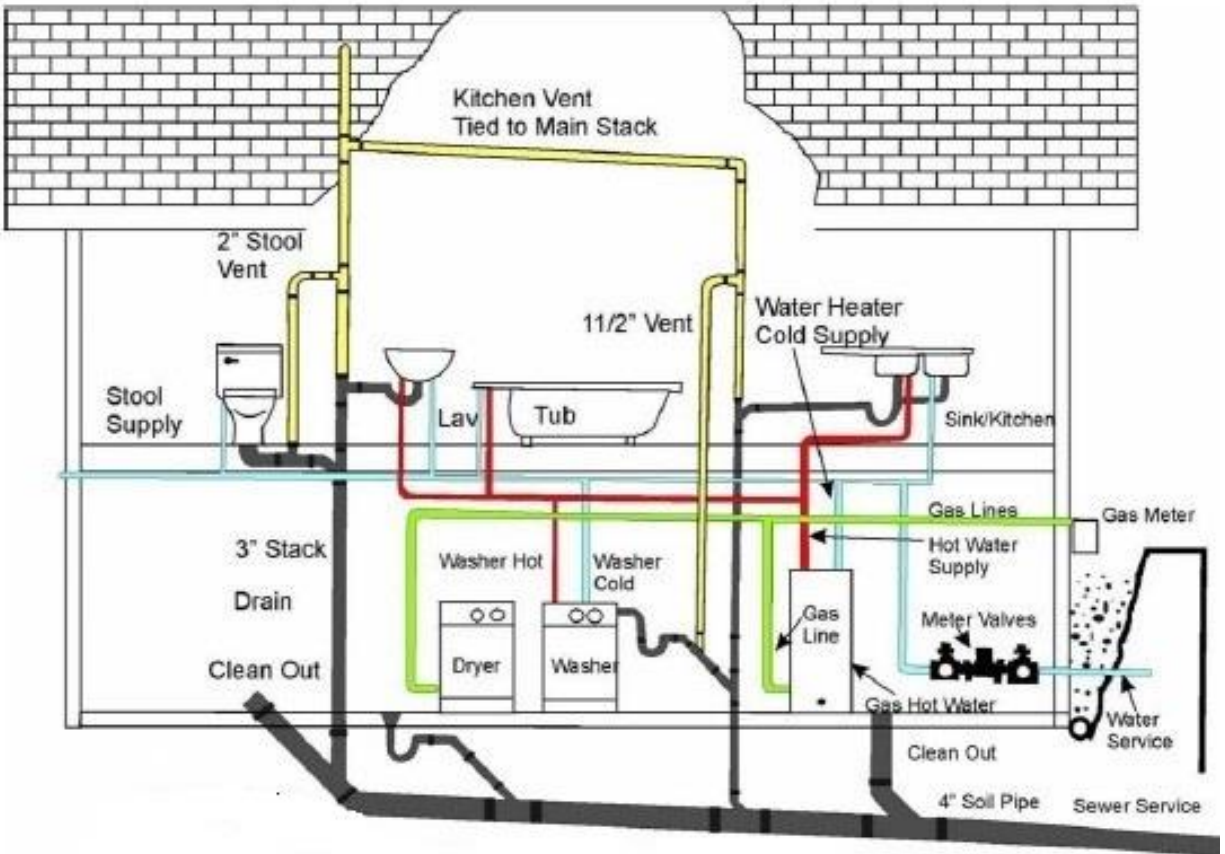

## Activity 1.2

### Group Discussion on Classification of Plumbing

The teacher/ instructor is required to direct the students to form groups of 5 students. The students have to note key points through discussion on classification of plumbing. Then a group leader will have to give presentation from each group for 3 minutes duration.

## Key Points

1. There are two basic systems of plumbing- water supply & drainage.
2. The main consideration during plumbing is that two systems should run side-by-side but do not intersect each other.
3. Flow in drainage must be gravity flow.
4. Plumbing is important for supply of water, saving human being, safety of building etc.
5. Pipe lines are the main components of plumbing.
6. Without appliances/ fixtures the system is just skeleton.
7. Scope of plumbing is wide from basics to fuel gas supply and air conditioning.
8. Fixtures are classified as fresh water fixtures, appliances, sanitary fixtures, gas fixtures and air conditioning fixtures.
9. Personal protective Equipments are necessary to prevent from accident of any type, safety from gases, noise and dust pollutions.
10. PPEs provide protection to head, hand, eye, body, foot, ears, nose and from falling.
11. Potable water, drainage & Venting, septic system, fuel gas piping, refrigeration and air conditioning are classes of plumbing.
12. Use proper PPE to safeguard yourself from accident.

## EXERCISE

### Multiple Choice Questions

**Q-1. Tick ( ✓ ) the correct option for the following MCQs.**

- 1- Fitting which is used for connecting service connection to main water line is.  
(A) ferrule valve                      (B) Reduce and coupling  
(C) Reduce and valve                (D) Reduce and union
  
- 2- Instant water heaters are:  
(A) Appliance                          (B) Fixture  
(C) Fitting                                (D) Appurtenances
  
- 3- The Flow of water in sanitary pipe should be:  
(A) Pressure flow                      (B) Forced flow  
(C) Gravity flow                        (D) Combined flow
  
- 4- The name employed for a fitting, having a larger size at one end than on the other:  
(A) Elbow                                 (B) Reducer  
(C) Tee joint                              (D) Union
  
- 5- This valve does not control the flow of water:  
(A) ball valve                            (B) gate valve  
(C) Air Release valve                (D) float valve
  
- 6- This is a face protective equipment:  
(A) safety goggles                      (B) safety belt  
(C) visor                                  (D) None of these
  
- 7- The traps are used to prevent the passage of:  
(A) foul gas                              (B) Waste water  
(C) Oxygen                                (D) Sewerages

- 8- This is an eye protection equipment:  
(A) over specs (B) belt  
(C) overall (D) None of these
- 9- A water meter is:  
(A) Appliance (B) Fixture  
(C) Fitting (D) Appurtenances
- 10- This is fitted with wash hand basin:  
(A) P-Trap (B) gully trap  
(C) q-trap (D) none of these

### Short Questions

#### Q-2. Answer the following short questions.

- 1- Enlist plumbing appliances.
- 2- Enlist sanitary fixtures.
- 3- Write down 3 considerations kept in mind during plumbing.
- 4- Enlist hand protection PPEs.
- 5- Enlist main components of plumbing system.
- 6- Write the difference between fitting and fixture.
- 7- Write name for each of the fixture shown in the figure below.
- 8- Write names of three appurtenances.
- 9- What is the use of P-trap?
- 10- What is the use of overall?

#### Answer the following question in detail.

- Q-1- Write a note on sections of plumbing.
- Q-2- Explain the classification of plumbing systems
- Q-3- Write the use of 16 PPEs.
- Q-4- Write down the considerations for plumbing system.
- Q-5- Write down the importance and basics of plumbing.

## CHAPTER 2 OCCUPATIONAL HEALTH AND SAFETY

Type	Fire	Class A	Class B	Class C	Class D	Electrical	Class F	Comments
		<b>combustible material</b> e.g., paper, Wood	<b>flammable liquids:</b> e.g., paint & petrol	<b>flammable gases:</b> e.g., butane, methane.	<b>flammable metals:</b> lithium & Potassium	<b>electrical equipment:</b> e.g., computers and Generators	<b>deep fat fryers</b>	
Extinguisher								
Water		✓	✗	✗	✗	✗	✗	Do not use on liquid or electric fire
Foam		✓	✓	✗	✗	✗	✗	No suited to domestic use
Dry Powder		✓	✓	✓	✓	✓	✗	Can be used safely up to 1000 volts
CO <sub>2</sub>		✓	✓	✗	✗	✓	✗	Safe on both high and low voltage
Wet Chemical		✓	✗	✗	✗	✗	✓	Use on extremely high temperature

### Students Learning Outcome

#### After Studying this chapter students will be able to:

- learn about the concept of health and safety.
- observe the basic rules of health and safety.
- learn the importance of personal protective equipment.
- learn the use of personal protective equipment.
- state danger posed by electric equipment.
- handle plumbing tools and electric equipment safely.
- define fire hazards.
- know fire triangle.
- state the use of different types of fire extinguishers according to class of fire.
- identify hazards and report it to concerned department.

Do you know?

Safety is a continuing journey not a destination.

## 2.1 Introduction to Health and Safety.

“The laws, rules and principles which are intended to keep people safe from injury or disease at site of work or in public places denotes health and safety”. Health and safety mean to provide an environment at work place to ensure the health and safety of workers. This can be achieved both by training the workers to adopt measure which are necessary for their health and safety. Environment of the workplace be clean, free from any source that can cause any type of hazard to the workers.

### 2.1.1 Concept of Health and Safety

It was assumed by most employers and the accident prevention bodies that most of the accidents were due to an employee’s failure to take safety seriously or to protect herself or himself. The suggestion of this is that work can be made safe simply by changing the behaviour of employees by poster campaigns and accident prevention training. So, the main concept is that health and safety policies can improve the performance of employees and the organization, by reducing costs associated with accidents, disabilities, absenteeism, or illness. The following principles of health and safety should be observed during workplace activities;

- i- All the peoples should be given the highest level of protection against risks to their health and safety that is reasonably practicable in the circumstances.
- ii- Any person who manages, owns or controls a workplace is responsible for eliminating or reducing those risks so far as practicable.
- iii- Employers and self-employed persons should be proactive and take reasonably practicable measures to ensure health and safety.
- iv- Employers and employees should exchange information and ideas about risks to health and safety and the measures that can be taken to eliminate or reduce those risks.
- v- Employees are entitled, and should be encouraged, to be represented on health and safety issues.

### 2.1.2 Basic Rules of Health and Safety.

The given here under are basic rules to be observed for health and safety.

- One should not work when he is tired.
- Latrine and urinal accommodation should be there at workplace.
- Supply of water fit for drinking.
- Know and observe the operating procedures at your workplace
- No smoking in buildings.
- Use of personal protective equipment where required
- Observe emergency facilities and procedures

- Take fire safety precautions
- Observe all safety signs.
- Observe lifting limits for machinery.
- Plan your work to minimize overuse syndrome risks.
- Avoid direct exposure with hazardous chemicals.
- Beware of electrical hazards.
- Assure yourself of others commitment to safety.
- The minimum fire protection requirements such as provision of fire alarm and detection system, fire extinguishers, emergency response plans and fire drills
- Employees shall be periodically instructed in the use of portable fire extinguishers.
- Conservancy shall be provided and maintained
- Medical appliances, supply of ambulances or stretchers, and of splints, bandages and other medical requirements, shall be kept ready at hand in convenient place and in good and serviceable order.
- First aid rooms of such size, with such equipment and in charge of such medical and nursing staff as may be prescribed.

#### **i. Precautions Against Fire**

- a) No person shall carry or have in his possession in a hazardous area any match, smoking apparatus etc.
- b) No electric light bulbs shall be changed or electric fittings altered in a hazardous area while the current is on.
- c) A layout diagram of firefighting services shall be prominently displayed.
- d) Each and every equipment installed or maintained in compliance with regulations and shall be tested or examined at least once in every week and also when an inspector so requires.
- e) Sufficient number of persons shall always be employed who are trained in the use of firefighting equipment provided in compliance with these regulations.
- f) Firefighting drills shall be carried out at least once a week
- g) Fire blanket shall always be kept readily available for use of persons affected by fire.

#### **ii. Personal Protective Equipment**

- No person shall be allowed to work or to be present at any place where a danger of head injury exists unless he is provided with and wearing a suitable safety hat.
- No person shall be allowed to handle hazardous chemical liquids, powders or vapors or to be present in the vicinity of such handling operations unless he is provided with and wearing a splash-proof safety goggles, rubber apron, mask, gloves and suitable footwear.
- No person shall be allowed to work or to be present at any place where a danger of injury to the eye from flying or falling particles or objects exists, unless he is provided with and wearing an impact-type safety goggles.



- No person shall be allowed to perform electric arc or acetylene gas cutting or welding or to be present near such operations unless he is provided with and wearing a suitably shaded safety goggle.
- No person shall be allowed to handle rough or moving surface unless he is provided with and wearing suitable hand gloves.
- No person shall be allowed to work at any place where there is a reasonable danger of foot injury, unless he is provided with and wearing safety shoes.
- No person while wearing neckties, gauntlet type gloves and baggy, loose or ragged clothing shall be allowed to work or be present around moving machinery.
- No person shall be allowed to enter any place where toxic vapors are present or there is deficiency of oxygen unless he has been provided with and is wearing a breathing apparatus of suitable type.
- The safety belts referred to in these regulations shall be of harness type and the safety belts and tail ropes shall be kept in good condition at all times.

### **Activity-2.1 Demonstrate Health and Safety Rules.**

The teacher/ instructor is required to demonstrate the students rules for health and safety about conservancy & general provision, medical appliances, First aid, precautions against fires, fire fighting & Equipment, Use of Personal protective equipment, Breathing Equipment and safety belts etc. The students have to demonstrate the same

### **Activity-2.2 Mock Exercise on Standard Operating Procedures (SOPs) of Health and Safety.**

The teacher/ instructor is required to plan mock exercise on safety and health rules in case of fire, wearing of PPEs, report general provisions for health and safety in the campus.

## **2.2 Personal Safety**

For the safety of workers, it is necessary to use personal protective equipment's. The parts of body which can be directly damaged by striking with machines or other things must be protected. A worker should protect his hands, feet, face, ear, eyes etc. from different types of dangers.

### **2.2.1 Importance of Personal Protective Equipment**

PPE, or Personal Protective Equipment, helps prevent staff emergencies on the job due to inhalation, absorption, irritants, or other prolonged contact with a cleaning chemical. This actively reduces accidents, improves the health of your employees, and makes for a safer, secure work environment. Safety is a major concern for any laborer. Accidents are extremely prominent in the construction industry due to the absence or inadequate use of Personal Protective

Equipment (PPE). PPE is equipment that protects workers against health or safety risks on the job and reduces employee exposure to hazards. The dangers can be anything from slippery wet floors to loose falling debris. PPE includes items such as protective helmets, eye protection, high-visibility clothing, safety footwear, safety harnesses and, sometimes, respiratory protective equipment.

**Do you know?**

It is important that your employer has taken action to control risks. You must know and follow safe working procedures – not just for your own safety, but also for the safety of others working with you.

**2.2.2 Use of Personal Protective Equipment**

One must know the proper personal protective equipment (PPE) required as per job requirements. The use of PPEs is given as under:

**i- Use of PPEs for the head:**

On the construction sites the most commonly used PPE for head protection are hard hats. They are designed to protect against flying or falling objects that would otherwise significantly harm the worker. Some hard hats come with face shields and earmuffs for further protection.

It is necessary that hard hats must fit well in order to work appropriately. Make sure that your team has well-fitting hard hats, otherwise their head protection will not be adequate. The bump caps can also serve the purpose. Head guard along with head gear accessories prevent a worker from any type of head injury. Helmets are also used for the purpose.

			
<p>hard hat and bump caps</p>	<p>helmet</p>	<p>Head guard Leather</p>	<p>head gear</p>

**ii- Use of PPEs for Eyes and Face**

Proper eye and face protection is extremely important. Safety goggles and full-face shields are available to protect the eyes and face. These equipments are used for hot-work and air-tool operations. Over specs prevent the eyes from harm of liquids, chemicals flowing toward eyes from eye surroundings. Face visors, eye wear accessories, face shields, safety goggles are also used for protection of face and eyes. Face masks prevent face from dust/ virus inhaling.

			
safety glasses	eye shield	over specs	eye wear accessory
			
safety goggles	face shield		face visor

**iii- Use of PPEs for Respiratory**

Respiratory protection should never be underestimated. It is truly essential on sites where toxic substances are present. This protection was created to protect you from dust, fumes, paint spray, pesticides and other harmful substances that could cause permanent damage. Respirators will likely be needed when sufficient ventilation is not attainable. Now a days Masks are compulsory in gathering for safeguard against COVID-19.

**iv- Use of PPEs for Hands and Skin**

Plumbing work normally requires a lot of hand use. A number of hand injuries are reported every year during plumbing work. Therefore, use of hand protective equipments must be ensured during plumbing job. Infections are the second most common type of occupational disease; hence glove usage is critical to protect the skin. Common PPE glove types are rubber, cut-resistant, chainsaw and heat-resistant gloves. Take advantage of gloves to avoid hazards involved with chemical, glass, sheet metal, electricity work.

### **v- Use of PPEs for Hearing**

Occupational hearing loss cases are reported during plumbing work, therefore the usage of ear protection is a must. Earplugs and earmuffs are common hearing protection tools. Note that earmuffs are effective in reducing high-frequency noise, while earplugs should be used for reducing low-frequency noise.

### **vi- Use of PPEs for Prevention from Falling**

Different types of safety belts are used to safeguard from falling. Safety belt is used with anchorage rope not more than 2m long or as per requirement. The full body belts are also used in severe situations. As a preventive measure, guardrails are also provided with the scaffolding.

### **vii- Use of PPEs for Foot Protection**

A pair of safety shoes (also known as safety boots) is personal protective equipment (PPE) for foot protection at workplace. It prevents from getting foot injuries due to slippery surface, heavy falling or rolling objects, sharp piercing edges, pinch points, rotary machinery, hot objects, loops of ropes under tension, splinters, electricity, chemicals or even bad weather etc.

### **Activity 2.3 Demonstrate Use of PPEs**

The teacher/ instructor is required to direct the students to demonstrate use of the following:

Safety gloves

Helmet

Safety belt

Industrial mask.

## **2.3 Safely Handling of Tools and Equipment**

For safely handling of tools and equipment you should observe the following points to avoid the different types of injuries during plumbing job.

- 1- The use of tools and equipments in specified manners must be ensured as per SOPs.
- 2- The instructions conveyed by the manufacturer should be strictly followed.
- 3- For safely handling of equipments it is necessary to have training of required tools and equipment.
- 4- Don't work in dark area.
- 5- Do not operate the tools & equipments with greasy / oily hands.
- 6- Use relevant personal protective equipments.

## Do you know?

Any faulty item of electrical equipment must be immediately withdrawn from use – it should be tagged (FAULTY – DO NOT USE) and removed from service until it has been repaired.

### 2.3.1 Danger Posed by Electric Equipments

The risks inherent with electric power can generally be divided into two categories: Direct and indirect.

The direct danger is the damage that the electricity power itself can do to the human body, such as stoppage of breathing or regular heartbeats, or burns. The indirect dangers of electricity also damage the human body such as a fall, an explosion, or a fire. The following measures should be adopted for safely handling of electric equipments;

- 1- It is necessary to operate the electric plumbing equipments as per instructions delivered by the manufacturer.
- 2- Never use the electric equipment without wearing safety equipment.
- 3- Never use the electric equipment unless it is passed by the technician safe for use.
- 4- Dangers of Electricity include a variety of hazards that include Electric Shock, Psychological Damage, Physical Burns, Neurological Damage and Ventricular fibrillation resulting in death. Shock from damaged equipment can cause severe and permanent injury. And can also lead to indirect injuries, due to falls from ladders, scaffolds, or other work platforms.
- 5- Faulty electrical appliances can also lead to fires. Any form of energy, when not properly controlled or harnessed, can result in serious danger to those who use it.

## Do you know?

### **Your employer must:**

- Have a maintenance program to make sure all tools are in safe working order
- Train you to use tools and equipment before you use it, and make sure you are supervised
- Provide any personal protective equipment needed and tell you how to wear and use it correctly.

### 2.3.2 Handling Plumbing Tools and Equipment Safely

A plumber installs, repairs, and maintains plumbing fixtures or systems in residences, industries etc. The job may include installation and repair of pipes, fittings, and fixtures servicing the water supply, waste disposal, and heating systems. Plumbers must also haul supplies, cut, and assemble plumbing materials, and use equipment and tools. Plumbing is a simple name for a job that has a wide variety of duties. A variety of hand tools, pipe cutting, and bending equipment, and power tools is necessary for working on plumbing materials. Keep your tools and equipment, and their safety features, in good working order. Keep cutting equipment sharp so it will work properly. While cutting, your face and body should not be in front of cutting tools, to avoid cuts and punctures. Use eye protection when cutting or grinding to avoid eye injuries from flying particles.

Do not use damaged tools and equipments. When you work in awkward positions or perform repetitive manual tasks, you are at risk for a musculoskeletal disorder. Make sure to use proper lifting techniques and keep your back straight while working. Try to rotate your tasks and take a quick break every 30 minutes.

**Note:** Students during performance of activities must **NOT** work where they could be exposed to electrical hazards.

#### Activity 2.4: Practice on use of Plumbing Tools.

The teacher/ instructor is required to give demonstration/ instructions to the students for safe use of plumbing tools. The students have to use on specific job main tools for marking, cutting, measuring and threading.

#### Activity 2.5: Demonstrate Safe use of Plumbing Electric Equipment.

The teacher/ instructor is required to give demonstration/ instructions to the students for safe use of plumbing Electric Equipments. The students have to use on specific job equipments for cutting and drilling.

#### Do you know?

The Five Groups of Hazards are:

- 1. Physical** such as noise, heat/cold stress, equipment, vibration, Ultra-violet (UV) rays, poor work practices

<b>2. Chemical</b>	such as during cleaning chemicals
<b>3. Biological</b>	such as resulting from cross-contamination and the resulting disease(s)
<b>4. Ergonomic</b>	such as resulting from poor seating position, repetitive manual tasks.
<b>5. Psychological</b>	such as resulting from overwork, high level of stress, poor work organisation, conflict or bullying

## 2.4 Fire Hazards

### Hazard

Anything with the potential to cause injury, harm or disease, for example a safety hazard, a health hazard or environmental hazard.

Fire hazards are a broad category. It includes anything which impedes the function of fire protection material or equipment, as well as anything that inhibits fire safe behaviour. For instance, an obstruction which impedes safe evacuation and a malfunctioning sprinkler system would both be considered fire hazards.

### 2.4.1 Definition of Fire Hazards

Fire hazards are workplace hazards that either involve the presence of a flame, increase the probability that an uncontrolled fire will occur, or increase the severity of a fire should one occur.

Fire hazards include:

- Flames
- Sparks
- Hot objects
- Flammable chemicals
- Chemical's accelerants, which can increase a fire's rate of spread

### 2.4.2 Fire Triangle

Hazardous substances that increase the risk of fire can be considered with respect to the fire triangle. Fire triangle is a model of the three conditions that are necessary to start a fire (fuel, an ignition source, and oxygen). A fire hazard is typically something that will either act as fuel or as an ignition source.

### 2.4.3 Types of Fire Extinguishers

Different types of fire extinguishers are used as per class of fire. Here under are shown types of fire extinguishers. These can be of different capacities.



1. Foam type    2. powder type    3. Water type    4. Wet Chemical    5. CO<sub>2</sub>

There are five types of fire extinguishers:

1. Water Extinguisher
2. Foam Extinguisher
3. Powder Extinguisher
4. Carbon Dioxide (CO<sub>2</sub>) Extinguisher
5. Wet Chemical Fire Extinguisher

There are six classes of Fires:

Class A Fire: produced by combustible material e.g., paper, Wood.

Class B Fire: produced by Flammable Liquids: e.g., paint & petrol.

Class C Fire: produced by flammable gases: e.g., butane, methane.

Class D Fire: produced by flammable metals: lithium & Potassium

Class E Fire: produced by electrical equipment: e.g., computers and Generators

Class F Fire: produced by deep fat fryers



Table showing the classes of fires, fire sources for each class and requisite type of fire extinguisher for firefighting purpose.

Type	Fire	Class A	Class B	Class C	Class D	Electrical	Class F	Comments
		<b>combustible material</b> e.g., paper, Wood	<b>flammable liquids:</b> e.g., paint & petrol	<b>flammable gases:</b> e.g., butane, methane.	<b>flammable metals:</b> lithium & Potassium	<b>electrical equipment:</b> e.g., computers and Generators	<b>deep fat fryers</b>	
Extinguisher								
Water		✓	✗	✗	✗	✗	✗	Do not use on liquid or electric fire
Foam		✓	✓	✗	✗	✗	✗	No suited to domestic use
Dry Powder		✓	✓	✓	✓	✓	✗	Can be used safely up to 1000 volts
CO <sub>2</sub>		✓	✓	✗	✗	✓	✗	Safe on both high and low voltage
Wet Chemical		✓	✗	✗	✗	✗	✓	Use on extremely high temperature

#### 2.4.4 Identify Hazards and Report

There are different kinds of expected hazards those can cause harm to the workers. Yet, these could be prevented if safety precautions are practiced and observed. The classification of hazards is given as under:

- Fire or explosion
- Accident with injury or illness (physical)
- Equipment failure
- Near hit or miss
- Property damage
- Spill or environmental release (chemicals)
- Other hazard or safety concerns

#### i- How to behave if hazard is observed.

If there is imminent danger, the person recognising the danger must:

- Take steps to isolate the danger by direct action, for example closing doors, evacuating the area etc.
- Warn the other persons and restrict entry of unconcerned persons.
- Inform the local body of firefighting.
- Contact with the fire brigade as soon as practicable.
- Prepare and submit a hazard report to the respective body.

## ii- Hazard Report

A hazard report is the most common way to report hazards. A hazard report form is the document used to ensure that appropriate actions are taken to prevent the hazard from turning into an incident - and also acts as the formal record of that hazard.

The format of the report is given as under:

### HazardReportForm

Date: \_\_\_\_\_ HazardReportNumber: \_\_\_\_\_

**ReportedBy:**

Name: \_\_\_\_\_ Position: \_\_\_\_\_

**ReportedTo:**

Name: \_\_\_\_\_ Position: \_\_\_\_\_

Sitelocation: \_\_\_\_\_

**Subject:**

Incident       Near Miss       Workplace Hazard       Hazardous Work Practice

**Description of Hazard:**

---



---



---



---



---

---

**What need to be done?**

---

---

---

---

---

---

---

---

Signatures: \_\_\_\_\_ Dated: \_\_\_\_\_

Copy Given to:

Manager: \_\_\_\_\_ (Signature)

Project Director: \_\_\_\_\_ (Signature)

**Activity 2.6: Demonstrate Different Types of Fire Extinguishers and Fire Safety Equipments.**

The teacher/ instructor is required to give demonstration/ instructions to the students for proper use of fire extinguishers for different kinds of fire. He should also demonstrate the fire safety equipment. The students have to demonstrate the use of fire extinguishers for different kinds of fire. He should also demonstrate the fire safety equipment.

**Activity 2.7: Demonstrate Various incidents reporting through role play**

The teacher/ instructor is required to give demonstration/ instructions to the students for mock practice for firefighting in case of fuel wood burning and oil burning. The students have to demonstrate the said incidents through role play i.e., practically use of fire extinguisher for firefighting. And submit the reports of both incidents to the role manager.

The teacher/ instructor should also demonstrate the mock practice of smoke detection alarm system. The same should be exercised by the students. And submit the report of this incident to the role of manager.

## Key Points

1. Health and safety mean to provide an environment at work place to ensure the health and safety of workers.
2. The work can be made safe simply by changing the behaviour of employees by poster campaigns and accident prevention training.
3. All the peoples should be given the highest level of protection against risks to their health and safety that is reasonably practicable in the circumstances.
4. Any person who manages, owns or controls a workplace is responsible for eliminating or reducing those risks so far as practicable.
5. Know and observe the operating procedures at your workplace.
6. The safety belts referred to in these regulations shall be of harness type and the safety belts and tail ropes shall be kept in good condition at all times.
7. Ensure you have a safe approved fire risk assessment.
8. No person shall be allowed to work or to be present at any place where a danger of head injury exists unless he is provided with and wearing a suitable safety hat.
9. No person shall be allowed to perform electric arc or acetylene gas cutting or welding or to be present near such operations unless he is provided with and wearing a suitably shaded safety goggle.
10. It is important that your employer has taken action to control risks. You must know and follow safe working procedures- not just for your own safety, but also for the safety of others working with you.
11. Any faulty item of electrical equipment must be immediately withdrawn from use – it should be tagged (FAULTY – DO NOT USE) and removed from service until it has been repaired.
12. Ladders should always be visually inspected prior to use, to make sure no damage or wear has occurred that could make them unsafe.
13. Workers must be informed of the health hazards of contact with sewage, and the safety measures which must be implemented to avoid exposure to risk.
14. Personal protective equipments are necessary to prevent from accident of any type, safety from gases, noise and dust pollutions.
15. Effective communication methods between fire wardens and workers during an emergency must exist.

## EXERCISE

### Multiple Choice Questions

**Q-1. Tick ( ✓ ) the correct option for the following MCQs.**

1. Hazard is anything with the potential to cause: injury, harm or disease  
(A) Injury (B) Harm  
(C) disease (D) All of these
  
2. Protective equipments are available for safety of:  
(A) Head (B) Eye  
(C) Face (D) All of these
  
3. The firefighting drill should be carried out at least:  
(A) Once a week (B) Fortnightly  
(C) Once a month (D) Once a year
  
4. For safety purpose the cutting tool should be:  
(A) dull (B) sharp  
(C) moderate (D) None of these
  
5. A fire hazard is something that acts as:  
(A) fuel (B) an ignition source  
(C) may be A or B (D) None of these
  
6. The equipment should be examined/ tested at least:  
(A) Once a year (B) Once a month  
(C) Fortnightly (D) Once a week
  
7. Which of the following fire extinguisher is used for fire fighting for electrical equipments/ installations?



**Answer the following question in detail**

1. What are the principles of health and safety?
2. State the rules of health and safety.
3. Write down importance of personal protective equipments.
4. State dangers posed by electric equipment.
5. Write detailed note on firefighting equipments.

## CHAPTER 3 PLUMBING TOOLS & EQUIPMENT



### Students' Learning Outcome

**After studying this chapter students will be able to:**

- identify measuring tools
- identify marking tools
- identify cutting tools
- identify threading tools
- identify drilling machines.
- identify grinding machines.



### 3.1 Identify Plumbing Tools

A plumber needs various categories of tools and machines to perform his job. These are measuring tools, marking tools, cutting tools, threading tools. He has to perform other jobs of jointing components, make holes, grind surface, bend pipes etc. Thus, in addition to above he needs pliers, wrenches, Scissors, vices, drills, files & rasps, jointing materials related tools, and other miscellaneous tools.

### 3.1 Identify measuring tools

Measuring involves linear dimensions, weight, pressure etc. Linear measurements may be for cutting pipes, location of fixture, alignment of fixture- vertical or horizontal, diameters of pipes. These tools in a workshop, which help the plumber to measure size and dimensions of various components of plumbing. These are vernier calliper, outside & inside callipers, screw gauge, steel measuring tape, steel ruler, pressure gauge, steel tri square, weight measuring scale, plumb bob, spirit level, protractors etc.

#### 3.1.1 Vernier caliper

Vernier calliper is a precision instrument used to measure the internal and external lengths. It is usually a manual calliper, as shown in Fig. It can also be digital.

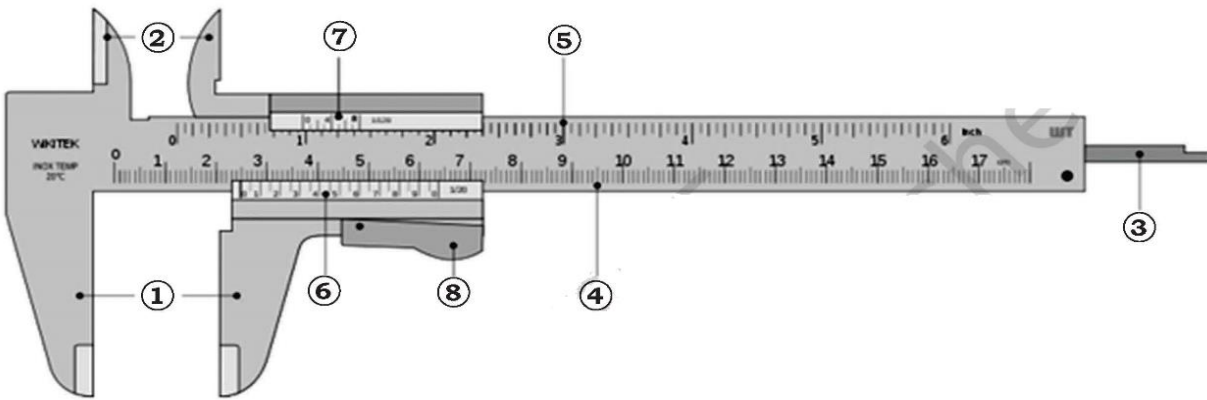

*Vernier Calliper*

- 1: used to take external measures of objects outside jaws
- 2: used to take internal measures of objects inside jaws
- 3: used to measure the depth of objects depth probe
- 4: (cm) Main scale
- 5: (inch) Main scale
- 6: (cm) Vernier
- 7: (inch) Vernier
- 8: used to block movable part retainer

### 3.1.2 Caliper

For measuring diameters. Having jaws for inner and external diameters.



*Outside Calipers*





*Inside Calipers*

### 3.1.3 Screw gauge (Micro meter)

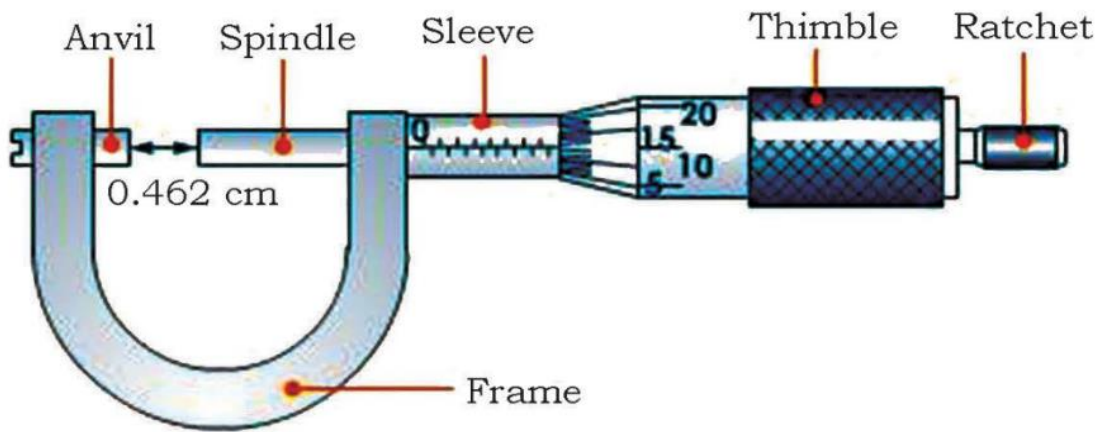
To measure small objects precisely.



*Screw Gauge*

<p>3.1.4 Steel Measuring tape It is used for measuring the long linear dimension of pipes or for layout.</p>	<p>3.1.5 Pressure gauge It is the instrument used for measuring the pressure in the pipe line.</p>
 <p>Steel Measuring Tape</p>	 <p>Pressure gauge</p>

### 3.1.6 Steel ruler

For measuring small lengths precisely.

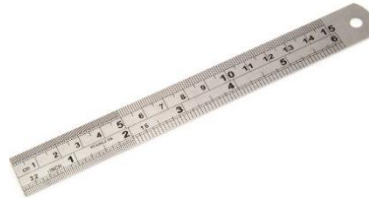

*Steel Ruler*

### 3.1.7 Steel Tri Square

This tool is used to align two parts at right angle before welding etc.



*Steel Tri Square*

### 3.1.8 Weight Measuring Scale

This is a dial type weight measuring tool. When load is placed on top, the needle on the dial rotates to indicate the weight as per scales marked round the periphery.

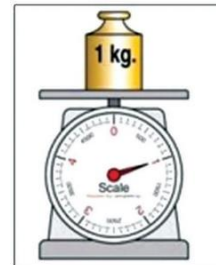

*Weight Measuring Scale*

### 3.1.9 Plumb Bob

A plumb bob to check verticality of pipeline. Its body is of steel or brass. A thread is fixed with its main body. Top end of thread passes between the hole of metallic strip.



*Plumb bob*

### 3.1.10 Spirit levels

Spirit level is used to check vertical and horizontal alignment of pipes, spaces, surfaces or objects.



*Spirit Level*

### 3.1.11 Protractor

Protractor is used to measure or mark required angles.



*Protractor*

### Activity 3.1: Enlist measuring tools.

Teacher/ instructor is required to place all types of tools in lab and direct students to separate from these measuring tools and allied tools/ accessories. The list of measuring tools along with their use to be note on the note book.

### 3.2 Identify marking tools

These tools are used to mark points, lines for location/ placing components, e.g., pipe wraps, nylon string, centre punch, compass or divider, counter marker, chalk lines, markers, pencils etc.

#### 3.2.1: Pipe Wraps

Pipe wraps are used to make markings on pipes for cutting them to various shapes.



*Pipe wrap*

#### 3.2.2 Nylon String

Nylon String can be used to do various long markings on pipes and any other markings.



*Nylon String*

#### 3.2.3 Center Punch

Centre Punch is used to make markings along cutting line for welding purpose. Location of centre of hole



*Centre punches*

#### 3.2.4 Compass or Divider

Compass or Divider can be used for inscribing circles or arcs.



*Compass*

### 3.2.5 Counter Marker

Contour Marker is used to mark circular marking on pipe periphery at various angles for cutting purpose.

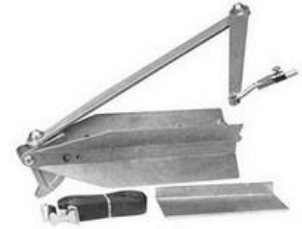

*Counter marker*

### 3.2.6 Chalk line

Chalk line is used to mark long straight lines on pipes or metal plates.



*(Chalk line)*

### Activity 3.2: Enlist marking tools.

Teacher/ instructor is required to place all types of tools in lab and direct students to separate from these marking tools and allied tools/ accessories. The list of marking tools along with their use to be note on the note book.

## 3.3 Identify cutting tools

In plumbing works, pipes are required to be cut. For the purpose different types of cutters are used. For example pipe cutter, tubing cutter, Ratchet plastic pipe cutter, electric pipe cutter (Jig saw), hacksaw, hole saw kit, reciprocating saw, internal PVC pipe cutter, chisels, etc.

### 3.3.1 Pipe cutter

Pipe cutter, as name indicates, is basically used for cutting pipes. A pipe cutter will have three wheels with hardened and sharp cutting edge along its periphery.



*Pipe cutter*

### 3.3.2 Tubing Cutter

A tool used by plumbers to cut through plastic and copper tubing, with each one having its own cutting range.



*Tubing cutter*

### 3.3.3 Ratchet Plastic pipe Cutter

As plastic pipes are softer in nature, therefore scissor type cutter is used to cut these pipes. It is shown in the picture. It is generally known as PPRC pipe cutter.

### 3.3.4 Electric Pipe cutter (Jig Saw)

Electric pipe cutter has one electric motor and one cutting wheel. Cutting wheel will be driven via electric motor and it will be adjustable too for compensating the various diameters of pipes.



*Electric pipe Cutter (Jig Saw)*

### 3.3.5 Hacksaw

Hacksaw is basically used for cutting pipes, fasteners, metal bar and rods. Workpiece will be fixed in vice and hacksaw will be used for cutting the workpiece at desired position. It comprises of frame, a blade, wing nuts and handle

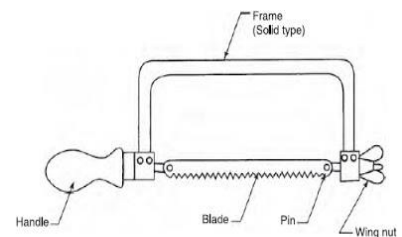

*hacksaw*

### 3.3.6 Hole saw kit

A hole saw is used to cut perfectly round holes in plastic sheets, wooden planks etc. it is fixed with drill machine.



*Hole cut saw*

### 3.3.7 Reciprocating saw

A reciprocating saw is a multi-purpose saw used to cut pipes, sheets and other object just like an ordinary saw but motorized drive.



*Reciprocating saw*

### 3.3.8 Internal PVC pipe cutter

This works with any electric drill to help you cut pipes. It works in places where there is no space to operate a pipe cutter, hacksaw etc. This accessory cut the pipe from inside.



*Internal PVC Pipe Cutter*

### Activity 3.3: Enlist cutting tools.

Teacher/ instructor is required to place all types of tools in lab and direct students to separate from these cutting tools and allied tools/ accessories. The list of cutting tools along with their use to be note on the note book.

## 3.4 Identify threading tools

In plumbing works, metallic pipes especially Galvanized Iron (GI) pipes are required to be jointed with the help of fittings. GI fittings have threads in inner side (female threads). So, pipes are required to be threaded on outer side (male threads). Sometimes, inside threading is also required. For the purpose different types of thread cutting tools are used. For example, threading dies, threading taps. To perform threading pipe vice, files, rasps de-burrers and reamers are also used. For jointing Teflon tape is wrapped on threads for leak proofing.

### 3.4.1 Threading dies

In order to provide the external threads over the surface of pipes, threading dies are used. Threading dies are also used to clean up the existing threads. The process using a die to create threads is called threading. The process using a die to clean up existing threads is called chasing.

Pipe is fixed in vice and threads will be made with the help of die and die stock with handle as displayed in following figure. The lubricating oil is used to ease threading. It also helps to remove burr and dust easily. Threading dies is displayed here in following figure.



*Threading dies with stock and handle*

### 3.4.2 Threading taps

In order to provide the internal threads, threading taps are used. Threading taps are also used to clean up the existing threads. The process using a tap to create threads is called tapping. The process using a tap to clean up existing threads is called chasing.

Nut is fixed in vice and threads will be made with the help of tap and tap stock with handle as displayed in following figure. The lubricating oil is used to ease tapping. It also helps to remove burr and dust easily.



*Threading taps with stock and handle*

### 3.4.3 Files and rasps

Files are used for planing/ grinding metal on small scale. Rasp is used for grinding surface of wood or plastic.



*Files*



*rasp*

### 3.4.4 Pipe vice

Pipe vice is used for gripping a pipe. bench type pipe vice, stand type pipe vice, chain type pipe vice.

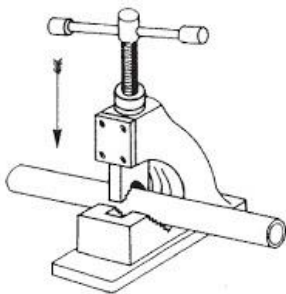

*Bench type Pipe vice*



*Stand Type Pipe vice*



*Chain type Pipe vice*

### 3.4.5 Miscellaneous

#### i- Plumber's Tape (Teflon Tape)

Plumber's tape is used to make the connections tight and leak-proof.



## ii- Pipe Reamer

A **pipe reamer** is a tool for removing burrs that appears when a pipe is cut. It is also used to increase the size of drilled hole to some extents. Deburring is performed using a dedicated **pipe reamer** suitable for materials such as PVC pipes, copper, steel, and stainless steel.



*ipe reamer*

## iii- Pliers

Different types of pliers are used everyday by plumbers. Easily tighten or loosen nuts and bolts those wrenches can't grab onto.



*Pliers*

## iv-Sledge Hammer

Sledge Hammer is used to apply forces to wrenches or to align things. Other hammers are claw, ball pein, cross pein, wooden.



*Sledge  
hammer*

## v- Screw Drivers

Screw drivers are used to tighten/loosen screws.



*Screw Driver*

## vi- Water Hose Level (Pipe Level)

This tool is used to align level of two piping or structure parts to exactly same elevation.



*Pipe level*

## vii- Melting Pot and Ladle

Melting pot is used for melting lead. Then pouring in ladle to ease pouring in the lead caulked joint.



*Melting pot*

*Ladle*

### **viii- Flashlight**

Plumbers are commonly required to go into dark spaces, such as basements, so having a flashlight handy is always a good idea.



*flashlight*

### **Plumbing Bucket**

Even when the water is turned off in the home, there is still going to be some water leakage, so it's smart to keep a bucket around.



*bucket*

### **Hand Drill Bits and Chisels**

These are used to make hole in the masonry, concrete etc.



*Hand drill bits*



*chisels*

### **Pipe and tube benders**

A tool used to bend a range of piping and tubing instead of creating a fitting.

### **Plumber's torch**

A plumber's torch is a handheld tool used to apply heat to a precise area of piping, allowing you to seal new piping for installs and replacements.



*Pipe and tube bender*



*plumber torch*

### **3.5 Plumber Wrenches**

#### **3.5.1 Adjustable Screw wrench**

A screw wrench is used for holding and turning the pipes.

#### **Fixed wrenches:**

Fixed wrenches are available with specific size and could not be adjusted.

#### **Adjustable Pipe wrench**

Used to tighten and loosen fittings on pipes.

#### **Chain Pipe wrench**

This wrench holds firmly the pipe in congested location.

#### **Strap Pipe wrench**

This wrench holds soft pipe in congested or any location.



*Screw Wrench Adjustable Pipe Wrench*

*Chain Pipe Wrench*

*Strap Pipe Wrench*

#### **Basin wrench (“Sink Wrench”)**

A T-shaped tool that plumbers use specifically on faucets

#### **Hammer Wrench**

Hammer Wrench has thick heavy end.

#### **Combination Wrench**

Combination Wrench have one end open and other box or circular type and are used to loosen or tighten the nuts.



*Basin/ sink wrench    hammer wrench*



*Combination wrench*

### **Faucet key**

An X-shaped tool that plumbers use to open and close spigots and sill cocks.

### **Torque wrench**

This tool is used to tighten the bolts as per specified torque in project specification. A tool used to apply a specific torque to a nut or bolt.

### **Spud Wrench**

This tool is used to align flange bolt holes together as well as tighten the bolts.

### **Internal pipe wrench**

Commonly used to remove old rusted fittings on galvanized pipe.



*Faucet key*



*Torque Wrench*



*spud Wrench*



*Internal Pipe Wrench*

## **3.6 Plumber Drain Cleaning Tools**

### **Plungers**

A tool used to clear up blockages in drains or pipes, commonly used in the household toilet. These are sink plunger, Toilet plunger, Master Plunger and Taze Plunger.



*sink plunger*



*Toilet plunger*



*Master Plunger*



*Taze Plunger*

### **Hand auger/ Snake Machine**

A hand auger has a long, flexible metal wire with a corkscrew auger attached on the end used to unclog drain lines.



*Snake Machine*

### **Activity 3.4: Enlist threading tools.**

Teacher/ instructor is required to place all types of tools in lab and direct students to separate from these threading tools and allied tools/ accessories. The list of threading tools along with their use to be note on the note book.

## **3.7 Identify Plumbing Equipment**

Along with hand tools, equipment and machines are also used in plumbing works. These are drilling machines, grinding machines, pipe bending machines, chain pulley block, winches, etc. Some of these are explained here under:

### **3.7.1 Drilling Machines.**

These are used for drilling holes in metals, plastics, metallic pipes, plastic pipes. There are different types of drilling machines. Drill machines are manual mechanically operated, portable electric drill machine, upright drilling machine and sensitive drilling machines.

#### **i- Portable Hand Operated Drill Machine**

Used to drill small sized holes. It is operated by holding in a hand. The workpiece where the hole is to be drilled is held in a vice.



*i- Hand operated drill machine*



*ii-Hand operated drill machine*

## ii. Portable Electric Drilling Machine

These types of drilling machines are used to drill small holes at high speeds in lighter jobs or workpieces. It can drill holes in walls, timber etc. For drilling holes in pipes or other metallic pieces, those are fixed in the pipe vice for the safety purpose.



*Portable electric drill machine*

## iii. Upright Drilling Machine

It is larger in size and stronger than portable electric drilling machine. It is used for drilling medium and large-sized holes. It is fixed type. Jobs are fixed on the platform provided on the pedestal. The drilling portion can be moved up and down with lever.



*Portable electric drill machine*

## iv. Sensitive Drilling Machine

These types of drilling machines are used to drill small holes at high speeds in lighter jobs or workpieces. Its base is heavy and is fixed with the floor. The drilling portion can be moved up

and down with separate motor. It is fixed type. Jobs are fixed on the platform provided on the table.

### **3.8 Grinding Machines.**

Grinding may be rough or smooth. Normally rough grinders are used in plumbing. For manufacturing of special mechanical parts precision grinders are used.

#### **3.8.1 Grinding Machine Types:**

##### **a- Rough Grinders:**

These grinders are meant for grinding surface roughly. The grinders in this category are floor or bench grinders, Portable grinders, Abrasive belt grinders, Swing Frame grinders

##### **b- Precision Grinders:**

Surface grinders, cylindrical grinders (plain, universal, and centerless grinders), tool and cutter grinders, internal grinders (chucking, planetary, and centerless grinders), special grinding machine. These grinders are beyond the scope of this book. Hence not discussed here.

##### **i- Floor or bench grinder:**

**Floor or bench grinder** is a small type of machine used in the labs where a small workpiece has to grind. For example, when we manufacture a single-point cutting tool e.g., a chisel grinding we use this floor or bench grinder.



*Floor or Bench Grinder*

##### **ii- Portable grinder:**

As the name indicates Portable that means it is not fixed at one point. The portable grinder is used for cutting pipes and tiles.



*Portable hand grinder*

### iii- Abrasive grinder:

The **abrasive grinder** is a similar type of these grinders but the main difference is here abrasive is used while cutting and finishing the job. This is more costly than the floor and portable grinder.



*Portable hand grinder*

### iv- Pencil Grinder

Pencil Grinder is used to clean surfaces off rust in tight places such as inside small pipes or holes.



*pencil grinder*

### v- Oxyacetylene Cutting Kit

Oxyacetylene Cutting Kit is used to cut large size pipes, elbows and steel plates using oxyacetylene flame.



*pencil grinder*

### vi- Pipe Bender

Pipe bender is used to bend pipe at required degrees without causing dents in wall or undue deformation.



### **vii- Hydro jetting machines**

An extremely effective method of clearing up drains and sewer lines. Comes with hose attachments that will blast water into drain lines and sewer lines.

### **viii- Pneumatic Pipe Cutting Machine**

Pneumatic Pipe Cutting Machine is an orbital pipe cutter working on air pressure.

#### **Activities-3.5: Recognition of Drilling Machines.**

The teacher/ instructor is required to direct the students for recognition of drilling machines in the school laboratory and nearby industry.

#### **Activities-3.5: Recognition of Grinding Machines.**

The teacher/ instructor is required to direct the students for recognition of grinding machines in the school laboratory and nearby industry.

Students shall also prepare the list of drilling machines and grinding machines.

### **Key Points**

13. There are different types of works in plumbing e.g., measuring, marking, layout, cutting, bending, threading, jointing, hoisting, welding etc.
14. Tools are classified according to the function and purpose they are used.
15. The main types of tools are measuring tools, marking tools, cutting tools, threading tools, drilling tools and jointing tools.
16. The most common measuring tools are measuring tape, spirit level, callipers, measuring scales.
17. The most common marking tools are centre punch, chalk line, pipe wraps.
18. The most common cutting tools are pipe cutter, hacksaw, tubing cutter.
19. The most common threading tools are ratchet threading dies, threading taps, and accessories are files, rasps along with vices, reamer, Teflon tape.
20. The common wrenches are adjustable screw wrench, pipe wrench, chain pipe wrench, hammer wrench and faucet key.
21. The most common drain cleaning tools are plungers and augers.
22. Common types of miscellaneous tools hammers, spanners, reamers, pipe and tube bender, bucket, Teflon tape.
23. Different types of machines are used according to function for cutting, drilling, grinding, Drain inspect & De-clogging, hoisting, welding.

24. The use of proper tool saves the life of tools and environment.
25. Drill machines are manual mechanically operated, portable electric drill machine, upright drilling machine and sensitive drilling machines.
26. Grinding may be rough or smooth. Normally rough grinders are used in plumbing. For manufacturing of special mechanical parts precision grinders are used.
27. The grinders in this category are floor or bench grinders, Portable grinders, Abrasive belt grinders, Swing Frame grinders.
28. Pipe bender is used to bend pipe at required degrees without causing dents in wall or undue deformation.

## EXERCISE

### Multiple Choice Questions

**Q-1- Tick ( ✓ ) the correct option for the following MCQs.**

- 1- Which of the following is not a measuring Tool.  
(a) Weighing Scale                      (b) Steel Ruler  
(c) Chalk line                              (d) Chain Block
  
- 2- Which of the following is a unit of length?  
(a) kg    (b) m  
(c) minute                                  (d) mL
  
- 3- Which of the following is a specific cutting tool for copper pipe?  
(a) Pipe Cutter                              (b) Cross Cut Saw  
(c) Tubing Cutter                            (d) Hacksaw
  
- 4- Which of the following is a tool to remove burr?  
(a) chisel                                      (b) screw driver  
(c) reamer                                      (d) none of these
  
- 5- Which of the following tool is used to clean toilet?  
(a) wrench                                      (b) faucet key  
(c) plunger                                      (d) all of these
  
- 6- Cleaning the old threads with the help of taps is called:  
(a) tapping                                      (b) chasing  
(c) threading                                      (d) all of these

- 7- Cleaning the old threads with the help of dies is called:
- (a) tapping                      (b) chasing  
(c) threading                      (d) all of these
- 8- Making threads with the help of dies is called:
- (a) tapping                      (b) chasing  
(c) threading                      (d) all of these
- 9- Making threads with the help of taps is called:
- (a) tapping                      (b) chasing  
(c) threading                      (d) all of these
- 10- It is a type of plunger:
- (a) taze                      (b) toilet  
(c) sink                      (d) all of these

## Short Questions

**Give short answer to the following questions.**

- 1- Enlist Measuring Tools.
- 2- State the purpose of centre punch.
- 3- Write down 3 types of drilling machines.
- 4- Enlist marking tools.
- 5- Enlist main types of wrenches.
- 6- Enlist 8 miscellaneous tools.
- 7- Why are safety tools used in plumbing work?
- 8- Why different types of cutters are used?
- 9- Why machines are being used instead of general tools.
- 10- Write down the use of reamers.

## Long question

### Answer the following question in detail

- Q-1- Give the examples of ordinary and automatic machines. Investigate why automatic machines are being used in commercial plumbing?
- Q-2- Give the examples of piping hand tools and machines. Investigate what type are likely to be extinct?
- Q-3- Explain different types of wrenches along with their use.
- Q-4- Explain the use of different types of machines
- Q-5- Prepare album of plumbing tools and machines.

### Material Required:

- i- Brochures of Plumbing tools and machines.
  - ii- Scissors
  - iii- Gum
  - iv- Coloured markers
  - v- Album
- a. Cut the pictures of three of each category of machines. Cut the pictures of 5 of each category of tools. The pictures can also be obtained from internet.
- Q-6- Paste the pictures on an album.
  - Q-7- Write the use of each tool and each machine in plumbing system.

## CHAPTER 4 MEASURING, MARKING & FILING



### Students' Learning Outcome

**After Studying this chapter students will be able to:**

- uses of measuring tools
- carryout measurements.
- identify measuring tools as per object to be measured or job requirements.
- perform linear measurement of different sizes of pipes.
- measure diameter of pipes (internal and external)
- know the correct tools for marking out.
- understand the use of marking tools.
- know the correct tools for filing.
- carry out method of using files.
- work piece filed.

## 4.1 Uses of measuring tools

These are important tools in a workshop, which help the plumber to measure size and dimensions of various components of plumbing. Measuring tools are commonly used. A plumber should know the use and handling of these tools. The important measuring tools are steel rule, calliper, screw gauge, pressure gauge, etc.

### 4.1.1 Steel ruler

It is used to measure lengths and to draw straight lines. It has linear units in inches and or centimeters. Conversion of units is given at paragraph 4.2.

### 4.1.2 Calliper

It is a tool used to determine the shorter lengths between two sides of an item. The tips of the calliper are kept to the distance to be measured; the calliper is then removed and the distance is measured between the tips with the ruler see figures. These are of two types-

**Internal Calliper:** for measuring internal dimension e.g., inner diameter of pipe. **External Calliper:** for measuring external dimension e.g., outer diameter of pipe, diameter of bar.

### 4.1.3 Screw gauge (Micro meter)

It is a device incorporating a calibrated screw used widely for precise measurement of small lengths. Proper handling of this tool is important in measuring any dimension.

### 4.1.4 Measuring tape (Steel & Hook type)

It is used for measuring the dimension of plumbing items. Tapes are available in various lengths like 10 metres, 20 metres, etc. Also, for imperial system in foot and inches are there.

### 4.1.5 Pressure gauge

It is the instrument used for measuring the pressure in the unit. For example, water pressure in pipe. These may be in pounds per square inch or kg per cm<sup>2</sup>.

### 4.1.6 Vernier calliper

The metre scale is used to measure the length to the nearest millimetre only. For measuring smaller lengths precisely, Vernier calliper is used. Vernier calliper is a precision instrument used to measure the internal and external diameters of pipe etc. It is usually a manual calliper. Digital vernier callipers are also available.

### 4.1.7 Steel Tri-Square

This tool is used to align two parts at right angle before welding, draw lines or align at 90 degrees, etc.

### **4.1.8 Measuring Scales (Length & Weight)**

To measure small length, length measuring scale is used. The units of measurements may be in inches or centimeters.

To measure the weight, weight measuring scale is used. The units may be in grams, ounce etc.

### **4.1.9 Plumb Bob**

A plumb bob is used as a vertical reference line, or plumb-line. It is essentially the vertical equivalent of a "water level".

### **4.1.10 Spirit levels**

Spirit levels can be used as a measuring device for the vertical and horizontal alignment of spaces, surfaces or objects.

### **4.1.11 Protractor**

Protractor is used to measure or mark required angles during piping fabrication angle is usually degrees. Angle may also be in grads or radians.

## **4.2 Carry out measurements.**

A plumber uses the metallic tape, cloth tape, scale and foot rule for measuring. Metallic tape should be used for accuracy in the measurement. Metre and its divisions are printed on the measuring tape. The symbol of feet is (') and the symbol of inch is ("). For example, the meaning of 4'-9" is four feet and nine inches. Both the systems, i.e., metric system and FPS (Foot- Pound-Second) system are used in plumbing measurement.

#### **(a) In metric systems**

1 metre = 10 decimetre (dm)

1 metre = 100 centimetre (cm)

1 metre = 1000 millimetre (mm)

10 millimetre = 1 centimetre (cm)

10 centimetre = 1 decimetre (dm)

10 decimetre = 1 metre (m) (b) In the FPS system

1 foot = 12 inches

3 feet = 1 yard

(c) Inter-relation of Metric and FPS system: Both type of systems can be interrelated, for taking length, in the following manner :

1 inch = 25.4 mm = 2.54 cm

1 metre = 39.37 inches = 1.09 yard



## Weight

1 kilogram	= 10 hectograms
1 kilogram	= 100 decagram
1 kilogram	= 1000 gram
100 kilogram	= 1 quintal
1000 kilogram	= 1 metric ton
1 kilogram	= 2.2046 pounds

## Conversion

1 millimetre (mm)	= 0.03937079 in, or about 1/25 in
10 millimetre	1 centimetre (cm) = 0.3937079 in
10 centimetres	1 decimetre (dm) = 3.937079 in
10 decimetres	1 metre (m) = 39.37079 in, 3.2808992 ft, or 1.09361 yd
10 metres	1 decametre = 32.808992 ft
10 decametres	1 hectometre = 19.927817 rods
10 hectometres	1 kilometre = 1093.61 yd, or 0.621377 metre

## Activity Use of Measuring Tools

The teacher/ instructor is required to give practical demonstration for the use of following as per lab environment.

**Steel ruler:** Use for measuring length of pipe, paper etc.

**Vernier Calliper, Inside Calliper & Outside calliper:** Use for measuring inside and outside diameters of different pipes, fittings etc.

**Screw Gauge:** Used for dia of wire, thickness of sheet etc.

**Measuring Tape (Push Pull Rule):** Used for measuring length of pipe, room, table. Also use to mark specified distance on pipe, wall or ground.

**Pressure gauge:** It is used to note pressure in pipe. Connect it with valve and note down pressure in pipe.

**Tri-Square:** Used to Check the squareness, to Check the flatness for Marking at 90° to the edges of work piece.

**Weight measuring scales:** Note weights of fittings etc.

**Length measuring scale:** Measure and mark dimensions on paper.

**Plumb bob:** Check verticality of pipe line on wall, and of leg of table.

**Spirit level:** Check the level of wash basin and other fixtures.

**Protractor:** Mark angle on paper and wall.

## 4.3 Perform Measurements

The teacher/ instructor is required to set job conditions and query to students to list measuring tools for individual jobs and perform measurements. For example

- For measuring lengths of pipe, room, table. Also used to mark specified distances on pipe, wall or ground.
- For measuring lengths of pipe, papers etc.
- For measuring diameters of wire, thickness of sheet etc.
- For measuring inside and outside diameters of different pipes, fittings etc.
- To note down pressure in pipes.
- Mark angles on paper and wall.
- Note weights of fittings etc.
- Check verticality of pipe line on wall, and of leg of table.
- Measure and mark dimensions on paper.
- Check the level of wash basin and of other fixtures.

#### **A: Measure the weight of a brick and fittings**

##### **Material Required**

1. Weighing unit (Weight measuring scale- analog or digital)
2. Brick
3. fittings
4. Notebook
5. Pencil

##### **Procedure**

1. Collect the brick and fittings.
2. Check and calibrate the weigh in unit.
3. Measure the weight of the brick and the fittings separately.
4. Note down the weight of items in the copy.

#### **B- The students are required to measure diameter of pipes (internal and external) as per directions of teacher/ instructor.**

##### **Material Required**

1. Vernier calliper
2. Inside calliper
3. Outside calliper
4. Steel rule

### **Procedure**

1. Collect the callipers and steel rule.
2. Identify pipe for measurement.
3. With the use of a vernier calliper to measure internal diameter in top jaws and external diameters of pipes in bottom jaws.
4. Note down both main scale and vernier scale readings. Add up the both and note down in the copy.
5. Use external calliper for outer diameter. Place the calliper on steel rule and note down outer diameter.
6. Similarly use internal calliper for inner diameter. Place the calliper on steel rule and note down inner diameter.

**C- The students are required to perform linear measurement of different sizes of pipes as per directions of teacher/ instructor.**

### **Material Required**

1. Measuring tape
2. Copy
3. Pipe Wraps or scriber

### **Procedure**

1. Collect the measuring tapes and scale.
2. Identify pipe for measurement.
3. With the use of a measuring tape and scale, measure the length of pipes.
4. Measure the dimensions in metres and convert into feet.

### **Activity 4.1: Practice to measure work pieces according to job requirements.**

The students are required to measure work pieces according to job requirements as per directions of teacher/ instructor. Teacher/ instructor has to mark pipe network on white board. Students have to measure the length of work pieces. Draw rough drawing of the pipe network and noted own the dimensions. Measure the dimensions in metres and convert into feet.

### **Activity 4.2: Perform linear measurement of different sizes of pipes.**

The students are required to measure work pieces according to job requirements as per directions of teacher/ instructor. Teacher/ instructor has to provide pipes of different diameters and lengths. Students have to measure the length of pipes. Measure the dimensions in feet and convert in to metres. Also check the measurements in metres by use of measuring tape.

### **Activity 4.3: Practice to measure diameter of pipes (internal and external).**

The students are required to measure work pieces according to job requirements as per directions of teacher/ instructor. Teacher/ instructor has to provide pipes of different diameters and lengths. Students have to measure the internal and external diameters of pipes. Measure the dimensions in milli-metres and convert into inches.

### **4.5 Select Marking Tools as per Job Requirements.**

The marking tool is used to mark on a job or work piece to obtain accurate size and shape. Before using marking tools on a job or work piece, firstly we should use marking media on it so that we can clearly see when marking. Marking tool is also called as a marking out tools.

The teacher/ instructor is required to set job conditions and query to students to list marking tools for individual jobs. For example

- Locate the position of fixture
- Mark the location of pipe
- Mark the vertical and horizontal alignment.
- Mark the location of appliances

The marking tools may be permanent markers, chalk crayons, Pipe wraps, nylon string, centre punch, Compass or divider, counter marker chalk lines, nails.

### **4.6 Understand the use of Marking Tools**

With help of these tools different locations on ground are marked. These are also used to mark cutting position of pipes. Another usage is to mark angle, vertical and horizontal alignments. A plumber should know the use and handling of these tools. The important measuring tools are markers, centre punch, pipe wraps, chalk crayons, compass, chalk line etc.

#### **4.6.1: Permanent Markers**

Permanent Markers- are needed to mark pipes, and walls. They do roll away so keep a few on hand.

#### **4.6.2: Chalk Crayons/ Coloured Chalks**

Chalk Crayons are good for the surfaces which aren't ideal for markers, like cement, and that quick game of tic tac toe during break.

#### **4.6.3: Pipe Wraps**

Pipe wraps are used to make markings on pipes for cutting them to various shapes.

#### **4.6.4: Nylon String**

Nylon String can be used to do various long markings on pipes and any other markings.

#### **4.6.5: Center Punch**

Center Punch is used to make markings along cutting line for welding purpose.

#### **4.6.6: Compass or Divider**

Compass or Divider can be used for inscribing circles or arcs. As dividers, they can also be used as tools to measure distances

#### **4.6.7: Counter Marker**

Contour Marker is used to mark circular marking on pipe periphery at various angles for cutting purpose.

#### **4.6.8: Chalk line**

Chalk line is used to mark long straight lines on pipes or metal plates.

### **How to measure & mark required length of pipe?**

#### **Tools & Materials**

Hook tape, measuring tape, marker, pipe wraps.

#### **Procedure:**

- Measure the GI pipes with hook tape and mark with help of marker and pipe wraps cutting locations.
- Measure the PPRC pipes with measuring tape and mark with help of marker are pipe wraps cutting locations.
- Measure and mark the location of service connection on main line with measuring tape and mark with help of marker are centre punch the drilling location.

### **How to measure & mark locations of fittings as per drawing?**

The students are required to mark the dimensions as per drawing for location of fittings, fixtures and appliances as per directions of teacher/ instructor.

#### **Tools & Materials**

Marker, steel tape, Steel scale, Plumb bob, chalk line.

#### **Procedure:**

- Measure with steel tape and mark with help of marker locations of pipe lines and fittings.
- Measure with steel tape and mark with help of marker locations of pipe lines and fixtures.
- Measure with steel tape and mark with help of marker locations of pipe lines and appliances.
- Measure with steel tape and mark with help of marker locations of pipe lines and drilling in wall for pipe.
- Measure and mark the location of service connection on main line with measuring tape and mark with help of marker are centre punch the drilling location.

#### **Activity 4.4: Identify work pieces according to job requirements.**

The students are required to mark work pieces like pipes etc., according to job requirements as per directions of teacher/ instructor.

#### **Activity 4.5: Mark the dimension as per drawing.**

The students are required to mark the dimensions as per drawing for location of fittings, fixtures and appliances as per directions of teacher/ instructor.

#### **Activity 4.6: Mark the point as per drawing.**

The students are required to mark points as per drawing for drilling, boring etc. as per directions of teacher/ instructor.

### **4.7 Select Filing Tools.**

File is common in plumbing tasks. A metal file is one of the most basic plumbing tools which is utilized to smooth or remove hard plastics and metals. Most of the files are hand tools, made of a case-hardened steel bar of rectangular, square, triangular, or round cross-section, with one or more surfaces cut with sharp, generally parallel teeth. A narrow, pointed tang is common at one end, to which a handle may be fitted.

A rasp is a form of file with distinct, individually cut teeth used for coarsely removing large amounts of material.

#### **4.7.1: Tools for Filing:**

Filing work may be for metals or plastic. Files used for metals are called metal files. The different types of files are according to cross sectional shape, cuts number etc.

##### *Types of metal files*

There various types of files are used for different jobs. The metal files used by plumbers are graded depending on the degree of caliber or coarseness and on whether their teeth are single or double cut.



##### **a- Single-cut metal files:**

Single cut files present teeth rows those are engraved parallel to each other at 65° angle from the centre line approximately. They represent the most appropriate tools for smoothening metal edges.

##### **b- Double-cut files:**

Double cut files present teeth rows which are crisscrossed so that they become diamond shaped for quick cutting. They are utilized by plumber for removing rapidly a material and for rough assignments.

<p><b>i- Hand file</b></p> <p>Parallel in width and tapered in thickness, used for general work.</p>	
<p><b>ii- Mill file</b></p> <p>The most common shape, single-cut, rectangular in cross section, with an even thickness throughout their length; they may be either parallel sided or taper slightly in width from heel to end.</p>	
<p><b>iii- Flat file</b></p> <p>Similar to a mill file, but may be double-cut.</p>	
<p><b>iv- Square file:</b></p> <p>Gradually tapered and cut on all four sides. Used for a wide variety of tasks.</p>	
<p><b>v- Three Square/ Triangular File:</b></p> <p>Triangular in cross-section, which may taper gradually, often to a point on smaller files. The sides may be equal in cross-section, or have two long and one short surface.</p>	
<p><b>vi- Rat tail</b></p> <p>Round in cross-section and gradually tapered over their length. They are used for enlarging round holes or cutting scalloped edges.</p>	
<p><b>vii- Round</b></p> <p>Round in cross section and equal diameter over their length (<i>not tapered</i>). They are used for smoothing inside holes and circular grooves, and for sharpening certain kinds of saw.</p>	

<p><b>viii- Half round files</b></p> <p>Half round file has one flat and one convex surface, and either tapering slightly or maintaining an even thickness, width, or both over their length.</p>	
<p><b>ix- Combination file</b></p> <p>Tangles, flat sided or half-round, with two to four cutting surfaces, typically including a combination of single cut, double cut, or rasp.</p>	

#### 4.7.2: Method of Using Files:

The filing process can be done as under:

Metal files have cutting teeth which are facing forwards and they are able to cut most effectively when they are pushed over the material. Different strokes are used to stabilize the cutting movement, having different outcomes. These are as under:

- In draw filing the movement of file is from each end and with a steady pressure. The file is pushed and pulled cross wise direction over the material.
- A variation of this movement is when the file is laid sideways on the material and then attentively being pulled and pushed across the material.
- Utilizing a combination of strokes and gradually finer metal files, a skilled plumber can make a material to be perfectly flat, with a mirror finish.

**Metal files** can be used in three main ways:

##### 1. For straight filing:

The file is pushed lengthwise directly forwards or somewhat diagonally across the material;

##### 2. For draw filing:

The file is grasped at both ends.

##### 3. For lathe filing:

The file is stroked against the material, which results in a lathe.

#### 4.7.3 Filing a Work Piece

Filing represents an industrial work that requires talent: the grip, pressure and stroke can differ, depending on each job.



For regular filing, the vice should be approximately at the height of the elbow. If a heavier filing is necessary, the material can be slightly lower.

- Read drawing
- File the work piece by using scale.
- Clamp work piece on the vice.
- File the work piece using appropriate file.
- Check filing surface level and perpendicular using by back square.
- Measure the final dimension.

#### Safety Precautions while doing Filing Work

- Select the proper file for the work.
- Ensure that tangs are protected by handles and that teeth are sharp and clean.
- Ensure the file used is fitted with a smooth, crack-free handle.
- The correct way to hold a file is to grasp the handle firmly in one hand and use the thumb and forefinger of the other to guide the point. Push the file forward while bearing down on it. Release the pressure and bring the file back to its original position.
- Don't pry or hammer with a file.

#### Activity 4.7: Filing of Work Piece

The teacher/ instructor is required to direct the students to perform filing a work piece of given dimensions. They should wear appropriate personal protective dresses etc. and observe relevant safety precautions in following steps.

#### Key Points

29. It is important to select appropriate tool for measuring length, diameter, weight etc.
30. The different measuring tools are steel tape, steel ruler, Callipers, plumb bob, spirit level, protractors etc.
31. It is important to know basic measuring units, sub-units and multiple units.
32. Proper use of measuring tool saves us.
33. Marking tools are used to mark location of any component on the site, e.g., pipe, fixture, fitting or appliance and marking on the work piece e.g., pipe or other work piece.
34. The main types of marking tools are permanent marker, chalk line, pipe wrap, center punch, compass/ divider, counter marker etc.
35. Use the proper marking tool as per requirements of job.

36. A metal file is one of the most basic plumbing tools which is utilized to smooth or remove hard plastics and metals.
37. A rasp is a form of file with distinct, individually cut teeth used for coarsely removing large amounts of material.
38. Types of files according to teeth's are single cut file, double cut file.
39. Types of files are Mill file, flat file. Square file, Triangular file, rat file, round file, half round file etc.
40. Filing is generally done by applying forward stroke. It can be done by backward stroke and combination of both.
41. The straight filing is by forward stroke in lengthwise. For draw filing, the file is grasped at both ends. For lath filing, the file is stroked against the material.

## EXERCISE

### Multiple Choice Questions

**Q-2- Tick ( ✓ ) the correct option for the following MCQs.**

- 1- Which vice is used for holding round sections of metals, tubes and pipes?  
(A) Pipe vice                      (B) Bench vice  
(C) Pin vice                        (D) Hand vice
  
- 2- The try square is used to:  
(A) Check the squareness                      (B) Check the flatness  
(C) Marking at 90° to the edges of work piece  
(D) All the above
  
- 3- This file is used for coarsely removing large amount of material:  
(A) Flat file                              (B) Rasp File  
(C) Rat File                              (D) Square File
  
- 4- This file is used for enlarging round holes:  
(A) Flat file                              (B) Rasp File  
(C) Rat File                              (D) Square File
  
- 5- To measure inside diameter of pipe tool used is:  
(A) Vernier Caliper                      (B) Inside Caliper  
(C) Outside Caliper                      (D) Both A & B
  
- 6- The verticality of pipe line is checked by:  
(A) water level                      (B) plumb bob  
(C) steel rule                      (D) None of these

- 7- To mark a long straight line tool used is:  
(A) chalk line                      (B) steel square  
(C) centre punch                      (D) All of these
- 8- Pipe wraps are used to:  
(A) cut pipes                      (B) mark on pipe  
(C) lay pipes                      (D) all of these
- 9- Marking level point for a long distance level is carried out by:  
(A) water level                      (B) spirit level  
(C) tri-square                      (D) None of these
- 10- In this type of filing, the file is grasped at both ends.  
(A) lathe filing                      (B) straight filing  
(C) draw filing                      (D) all of these

**Write short answer of the following questions**

- 1- Enlist measuring tools.
- 2- Enlist Marking Tool.
- 3- Write down uses of 3 measuring tools.
- 4- Enlist Types of files.
- 5- Convert 2 ft 7” to millimeters.
- 6- Enlist parts of vernier caliper.
- 7- Why are safety precautions adopted in using tools?
- 8- Why appropriate tool selection is important?
- 9- Why work piece is grasped before filing.
- 10- What is meant by pushing and pulling in the process of filing?

## Answer the following questions in detail

### Answer of the following question in detail

1. Describe the procedure for different types of measurements carried out in plumbing works?
2. Explain marking to be carried out in plumbing works?
3. State the use of following tools in plumbing
  - i. Vernier Calliper
  - ii. Steel measuring tape
  - iii. Spirit Level
  - iv. Plum bob
4. Explain different methods of filing a work piece.
5. Start project for making model of water supply of dead end and radial system. Mark the lengths, and cut pipes as per drawing provided by the teacher/ instructor.

## CHAPTER 5 CUTTING & DRILLING



### Students' Learning Outcome

After Studying this chapter students will be able to:

- know the correct tools for cutting
- cutting of pipes of different metals, dimensions and sizes
- state importance of drilling.
- know about types of drill bits.
- state the procedure of drilling in different materials.

## **5.1 Pipe Cutting.**

We need to change direction of pipeline or fix a fixture in the way. For this purpose, we have to cut plumbing pipes. Different types of cutting tools are used for different pipes.

### **5.1.1 Select Cutting Tools**

We use different types of cutters to cut the pipes. These are pipe cutter, tubing cutter, Ratchet plastic pipe cutter, electric pipe cutter (Jig saw), hacksaw, hole saw kit, reciprocating saw, internal PVC pipe cutter, chisels, etc.

#### **a- Pipe cutter**

Pipe is grasped in pipe vise. Pipe cutter has 3 wheels. One wheel is adjustable. Pipe cutter is adjusted with help of adjustable wheel to the desired distance for accommodating the various sizes of pipes with help of knob. Cutter is turned around the pipe and cutter wheel will cut the pipe along a circle. The cutting wheel is again tightened and moved round the pipe. Ultimately the pipe is cut.

#### **b- Tubing Cutter**

A tool used by plumbers to cut through plastic tubing, copper, with each one having its own cutting range. The process is the same as for pipe cutter.

#### **c- Ratchet Plastic Pipe Cutter**

This cutter is used to cut plastic pipes. It is just like a lockable scissor. Pipe is cut in multiple pressing of cutter. The cutting process is the same as we use scissor for cutting papers, thread etc.

#### **d- Jig Saw (Electric Pipe cutter)**

Cutting wheel is driven via electric motor and it is adjustable too for compensating the various diameters of pipes.

Once pipe is gripped properly, cutting wheel will be started and pressed along the pipes to cut the pipe.

#### **e- Hacksaw**

Hacksaw is basically used for cutting pipes, fasteners, metal bar and rods. Pipe is fixed in vice and hacksaw is used for cutting the work piece at desired position. Hacksaw blade is moved over the work piece in forward and reverse direction for cutting the given work piece. It cuts normally in forward stroke.

Other cutting tools are reciprocating saw (Manual and motorized), Internal PVC pipe cutter, Hole saw, Chisel, Pocket Knife, Pair of Scissors, Hand Cutter machine, Miter saw, keyhole saw (also called a pad saw, alligator saw, jab saw or drywall saw), Oxyacetylene Cutting Tool.

### **5.1.2: Cutting of pipes of different metals.**

#### **a- Cutting of pipes**

Measure the diameter and length of pipe.

Mark the location of cutting with help of pipe wrap and marker.

Fix the pipe in pipe vice.

Select the appropriate cutting tool and cut the pipe.

Repeat the above steps for other pipes with varying cutting tools.

### **b- Safety Precautions during Cutting of pipes**

#### **i- Safety Precautions whiles using Sharp cutting tools**

1. Use a knife only for the correct purpose.
2. Keep hands behind the cutting edge at all times.
3. Never cut towards yourself, always cut away from your body.
4. Where possible, use a cutting board under neath the material being cut.
5. Always pass knives to others handle first.
6. Never run with knives or push/shove people around using knives.
7. Ensure knives are kept sharp–blunt knives can be dangerous.
8. To clean, wipe the blade with a cloth keeping the knife' sharped get turned away from the hand
9. Do not substitute knives for can openers, screw drivers, or ice picks.
10. Replace orshar pen any cutting tool that has lost its correctly angled cutting edge.
11. Dispose of all broken or blunt blades in asharps container.
12. Only use wire cutters for cutting light gauge wire or component leads. Do not use to cuts heet metal.
13. Hand shears used for cutting sheet metal should be selected for the type of cut based on the side the waste material lies.

#### **ii- Safety Precautions while using saws:**

1. The work piece should be securely held in a vice or other firm support.
2. When crosscutting, start the cut with two long slow pulls upwards.
3. When ripping, start the cut with the finer tee that the end of the blade.
4. During the cutting process, apply down ward force only on the forward cut not when drawing back.
5. As the cut approaches completion, reduce the force applied to the saw to avoid breaking through the material and injuring hand.

### **Activity-5.1: Practice of Cutting pipes of Different Materials**

Teacher/ instructor is required to direct students in lab to cut GI pipes, PPRS pipes, PVC pipes of specified lengths, sizes, with the help of all cutting tools observing all safety precautions. Also wear necessary personal protective equipments as per job requirements.

### **Activity-5.2: Cutting Copper Tubing**

Teacher/ instructor is required to direct students in lab to cut copper tubing of specified lengths, sizes, with the help of tubing cutter observing all safety precautions. Also wear necessary personal protective equipments as per job requirements.



## 5.2: Drilling

The process of making holes with the help of drill bits or by means of rotating tool is known as drilling. Holes are required to be drilled in walls, timber, metals and plastic during plumbing work. For the purpose of drilling various types of drilling machines are used.

### 5.2.1 Importance of drilling.

Drilling is of great importance in plumbing works. It is important to have one by your side to drill all the necessary holes for pipes to pass through. By the use of chisels for making holes there are great chances of damage to the building. And also, the damaged portion requires repair. The repairing work require financial resources and also outlook is not good of repaired portion. Hence drilling is essential for plumbing work.

### 5.2.2 Types of Drill bits.

Drill bits are of various types according to materials, shape and the material for which they are used for drilling. The material for which drilling is done can be various types of wood, metal, plastic, ceramic tile, porcelain, and concrete. Drill bits are also available for steel, aluminum, copper, cast iron, sheet metal, fiberglass, brick, vinyl flooring, and more.



*Spur wood, Diamond, Flat wood, Auger Bit, HSS Metal, Spiral Masonry*

The following are the most commonly used drill bits.

Spur wood bit, Auger Bit, Flat wood or Spade Bit, HSS metal bit SDS Masonry Bits, Normal Masonry Bit, Counter Sink & Pilot Hole, Quick Release Bit Holder, tungsten carbide drill. Tungsten Carbide is strongest type of drill, although it is brittle.

Other types may be Straight fluted drill, Twist drill, Double fluted drill, Multi-fluted drill, Centre drill, Counter boring drill, Oil hole or

For drilling in wood a set of twist and auger drill bits are used.

For drilling in metal Titanium, cobalt and tungsten bits are used.

For drilling in concrete, to be specific, you should have a set of masonry bits that are optimized for stone and concrete drilling jobs. In particular, you should look for a set with carbide tips because these will best be able to resist wear caused by heat build-up during the boring process.

### **Types of Drilling Machines**

There are different types of drilling machines. Only four of them are described here. Others are beyond the scope of this book. Drill machines are manual mechanically operated, portable electric drill machine, upright drilling machine and sensitive drilling machines.

#### **i. Portable Hand Operated Drill Machine**

These types of a drilling machine are commonly used in all the workshops. Used to drill small sized holes. It is operated by holding in a hand. The workpiece where the hole is to be drilled is held in a vice.



*Hand Portable Drilling Machines*

#### **ii. Portable Electric Drilling Machine**

These types of drilling machines are used to drill small holes at high speeds in lighter jobs or workpieces. It can drill holes in walls, timber etc. For drilling holes in pipes or other metallic pieces, those are fixed in the pipe vice for the safety purpose.

#### **iii. Upright Drilling Machine**

It is larger in size and stronger than portable electric drilling machine. It is used for drilling medium and large-sized holes. It is fixed type. Jobs are fixed on the platform provided on the pedestal. The drilling portion can be moved up and down with lever.

#### **iv. Sensitive Drilling Machine**

These types of drilling machines are used to drill small holes at high speeds in lighter jobs or workpieces. Its base is heavy and is fixed with the floor. The drilling portion can be moved up and down with separate motor. It is fixed type. Jobs are fixed on the platform provided on the table.

Since the operator senses the cutting action at any instant it is called as the sensitive drilling machine. These machines are capable of drilling small holes of diameter as small as 0.35 mm to 15 mm. These machines run at a higher speed as high as 2000 rpm.



*Electric Hand Drill Machine*



*Upright Drilling Machine*



*Sensitive Drilling Machine*

### **5.2.3 Procedure of drilling**

Make sure that the bit is sharp before installing it. Do not leave the key in the chuck and do not adjust the height of the drill press with a piece of wood. Take the time and effort to bend down and reach under to adjust the height of the platform. Clamp objects that could spin or move. The following stepwise procedure should be observed for the drilling.

- Choose the right drill bit set
- Find and mark drilling spot.
- Use masking tape to mark the correct depth on your bit.
- Put on safety goggles and a dust mask before you start drilling.
- Place your bit on the point where you'd like to drill and squeeze the trigger.
- Increase the speed of the drill while applying pressure.
- For metal use lubrication to avoid damage to the drill bit.
- Withdraw the bit with the drill still on when you reach the desired depth.
- Tap in your anchor if you're using one. Or clear hole and pass pipe.

### **Safety Precautions during Drilling**

Safety Precautions while using Drills:

- i. Tighten drills correctly in the chuck.
- ii. Before starting the drill, always remove the chuck key (if applicable) from the chuck – never leave the key in the chuck.
- iii. Only sharp drill bits should be used. Never use dull, chipped, rounded, or tapered drill bits.

- iv. Remove the drill bit before storing drill.

### **Activity 5.3: Practice for drilling in pipes.**

The teacher/ instructor is required to direct the students to perform drilling in metallic, concrete and plastic pipes. They should observe all the precautionary measures for using tools and wear requisite personal protective equipments.

### **Activity 5.4: Drilling on different materials.**

The teacher/ instructor is required to direct the students to perform drilling in metals, concrete, wood, stone and plastic sheets. They should observe all the precautionary measures for using tools and wear requisite personal protective equipments.

## **Key Points**

- 42. Cutting tools include pipe cutters- for GI pipes, Tubing cutter for copper pipe. Similarly, are hacksaw, PPRC pipe cutter, motorized cutters.
- 43. Other cutting tools are reciprocating saw (Manual and motorized), Internal PVC pipe cutter, Hole saw, Chisel, Pocket Knife, Pair of Scissors, Hand Cutter machine, Miter saw, keyhole saw (also called a pad saw, alligator saw, jab saw or drywall saw), Oxyacetylene Cutting Tool. The main consideration during plumbing is that two systems run side-by-side but do not intersect each other.
- 44. Always observe safety precautionary measures while using tools.
- 45. Wear personal protective equipments for self-safety.
- 46. Drilling in plumbing is required for making holes in pipes and other materials.
- 47. Drilling is important for safety of existing structures of any type of material.
- 48. Always use proper drill bit as per job requirements.
- 49. Strongest type of drill bit is of tungsten carbide. Other materials best for drill bits are titanium and cobalt.
- 50. Always use marking tool for specified depth of hole.
- 51. Main types of drill bits are Spur wood bit, Auger Bit, Flat wood or Spade Bit, HSS metal bit, SDS Masonry Bits, Normal Masonry Bit, Counter Sink & Pilot Hole, Quick Release Bit Holder, tungsten carbide drill.
- 52. Perform drilling process in steps. Never miss any intermediate step for your and machine safety.

## EXERCISE

### Multiple Choice Questions (MCQs)

**Q-1. Tick ( ✓ ) the correct option for the following MCQs.**

- 1- This type of cutting tool is generally used for cutting copper pipe.  
(A) pipe cutter                      (B) Tubing Cutter  
(C) hacksaw                          (D) None of these
- 2- The process of making holes by means of rotating tool is known as:  
(A) Drilling                          (B) Reaming  
(C) boring                            (D) None of these
- 3- The process of cutting pipe include:  
(A) measuring length      (B) mark the location  
(C) Fix the pipe in vice      (D) All of these
- 4- This should be the property of drill bit set:  
(A) Dull                                (B) chipped  
(C) Sharp                               (D) Tapered
- 5- This type of bit is used for drilling in wood:  
(A) Spade bit                        (B) HSS Metal bit  
(C) Spiral masonry bit      (D) None of these
- 6- Jig saw can cut this type of pipe:  
(A) GI Pipe                          (B) PPRC pipe  
(C) Steel pipe                        (D) all of these
- 7- This type of drill machine is used for drilling in wall normally  
(A) portable electric      (B) upright  
(C) manually operated      (D) None of these
- 8- This is a cutting tool:  
(A) hacksaw                        (B) chisel  
(C) pipe cutter                      (D) all of these

- 9- Drill bit is gripped in:
- (A) stock (B) chuck  
(C) assembly (D) None of these
- 10- Lubricant is used during drilling to prevent drill from:
- (A) damage (B) bending  
(C) cracking (D) all of these

### Short Questions

#### Shortanswer to the following questions.

- 1- Enlist tools for cutting pipes.
- 2- Enlist drill bits for drilling in wood.
- 3- Write down 3 considerations kept in mind during drilling.
- 4- State 3 precautionary measures adopted in cutting of pipes.
- 5- State 3 precautionary measures adopted for drilling in pipes.
- 6- Write down bits types according to shape.
- 7- Why is it important to select proper cutting tool?
- 8- Why PPRC pipe cutting tools are different than those for G.I. pipes?
- 9- Why is it necessary to wear personal protective equipments during drilling process?
- 10- Why chisels are used for cutting cast iron pipes?

### Long Questions

#### Answer the following question in detail

1. Explain the use of cutting tools.
2. Explain safety precautions observed while using cutting tools.
3. Explain procedure of cutting different pipes.
4. A- State importance of drill bits  
B- State types of drill bits.
5. Explain the procedure of drilling with the help of:  
I- Portable hand operated drill machine  
II- Portable electric drill machine

## CHAPTER 6 THREADING & REAMING



### Students' Learning Outcome

After studying this chapter students will be able to:

- identify tools for threading.
- adopt safety measures
- fix work piece for threading.
- fix chasers in threading die.
- identify tools for reaming.
- adopt safety measures
- fix work piece for reaming.
- observe ohsa

## 6.1: Perform Pipe Threading

Galvanized Iron (GI) pipes are usually threaded for jointing with fittings. For this purpose, different tools are used. These may be dies, taps etc.

Do you know?

Threading is performed in two ways- internal and external:

### **Male Threading:**

Threading is performed on outer surface of the pipe. This threading is known as male threading.

### **Female Threading**

Threading in the fitting is performed on its interior surface. This threading is known as female threading.

### 6.1.1: Threading Tools

There are mainly two categories for threading depending upon the type of threads- male and female threads. The tools used are:

- i- Dies- solid stock and ratchet dies
- ii- Taps with holders.

#### *i- Threading Dies*

In order to provide the external threads over the surface of pipes, threading dies are used. For male threading dies are used. These are solid stock type and ratchet type. Ratchet dies are easier to use because they allow backward stroke without rotation on pipe of chasers. Threading dies are also used to clean up the existing threads. The process using a die to create threads is called threading. The process using a die to clean up existing threads is called chasing.

Pipe is fixed in vice and threads will be made with the help of die and die stock with handle as displayed in following figure. The lubricating oil is used to ease threading. It also helps to remove burr and dust easily.



*Threading dies with stock and handle*



## *ii- Threading Taps*

In order to provide the internal threads, threading taps are used. Threading taps are also used to clean up the existing threads. The process of using a tap to create threads is called tapping. The process using a tap to clean up existing threads is called chasing.

Nut is fixed in vice and threads will be made with the help of tap and tap stock with handle as displayed in following figure. The lubricating oil is used to ease tapping. It also helps to remove burr and dust easily.



*Threading taps with stock and handle*

Various types of taps are used for female threading. The internal threading may be uniform or taper type in threading length.

## *iii- Bottoming Tap*

A bottoming tap has almost no taper at the end because it is designed to thread all the way to the bottom of its reach. Only 1 to 1.5 threads will be tapered.

Bottoming Taps are useful for threading blind holes. It's desirable to thread most of the hole with a Taper Tap first, and then finish the bottom of the hole with a Bottoming Tap.

## *iv- Plug Tap*

Plug Taps are in between Bottoming and Taper Taps because they have 3-5 threads tapered, which is more than a Bottoming Tap and less than a Taper Tap. Taps use are hand operated and power operated.

## *v- Taper Tap*

A taper tap has quite a lot of taper to help it ease into cutting threads gradually. Typically, the first 8 to 10 threads are tapered. Taper Taps are the most common types of taps and are typically what you'll have in a Tap and Die Set.

### **6.1.2 Adopt safety measures**

Exercise care where rough or sharp edges may be present. Clean up any coolant spills and keep floor clean of swarf and chips. Eye protection must be worn. Hand protection must be worn. Keep work area clean

- 1- Always follow instructions and manuals on the proper use of this machine provided as per the manufacturer's directions.
- 2- Avoid its uses for another purpose rather than its real purpose of **threading**, such as drilling holes.
- 3-Always secure the pipe in pipe vice for manual threading. If pipes are too long, they must be given supports.
- 4-Before the operation, remove hex keys and adjusting wrenches from the machine. And never force machines or appliance.it will reduce the ratio of the incident.
- 5-Always use the manufacturer's recommended accessories.
- 6-Never use machines in case switches are broken or switch does not function it ON or OFF.
- 7-All damaged parts of the machine and alignment of moving parts before using machines must be double-checked.
- 8-Before, during or after service, always keep their handles dry and clean and free from oil and grease contamination for better control of the machine and or appliance.

### **6.1.3: Fix work piece for threading**

Put on work gloves and safety glasses. Loosen the jaws of the vice by turning the handle counterclockwise just far enough to fit the pipe between them. Place the pipe in the vice so the end you want to thread is facing out, then turn the handle back clockwise to tighten it and secure it in place.

### **6.1.4: Fix chasers in Threading die and perform threading**

#### **a- Fix Chasers in Threading Die**

Choose a die head based on the pipe's diameter. Attach the die head to a ratcheting pipe threader handle. Use the instruction manual and insert the requisite size of chasers in the die stock. Use the screw wrench for fixing the chasers in the stock.

#### **b- Perform Threading**

Place the die head onto the end of the pipe. Slide the center hole of the die cutter onto the end of the pipe. Push it into place as far as it will go. Push against the die head, towards the pipe, with one hand. Ratchet the pipe threader's handle clockwise with your other hand as far as you can go, maintaining pressure on the die head as you do so to make the teeth start cutting into the pipe.

Lubricate the exposed teeth of the die head. Turn the handle back counterclockwise about 3/4 of the way, then ratchet it clockwise as far as you can go, using your bodyweight to help you turn it. Repeat this until all the die head's teeth are around the pipe, which means all the threads have been cut.

Pull up the little black knob next to the die head and turn it to reverse the direction of the ratchet handle. Ratchet it counterclockwise as far as it will go, then turn it back clockwise about 3/4 of the way, and repeat until you have unscrewed the teeth of the die head from the threads. Seal the threads with 2-3 wraps of teflon tape before you attach any connectors or fittings. This will ensure a tight, well-sealed connection.

#### **6.1.5: Observe OHSA**

- Do not perform threading with greasy or oily hands.
- Wear work gloves and safety glasses to protect yourself while threading a pipe.
- If your pipe was metal, be cautious about getting the shavings on your skin as they will be sharp.
- Squeeze more threading oil onto all the teeth of the die head that are not yet cutting into the pipe. This is important to make cutting easier and prevent wear and tear on the teeth.
- Don't be shy about squirting on the threading oil. You can't use too much lubricant during this process. Clean the teeth of die by sweeping them off with brush.

#### **Activity-6.1: Practice of External threading of pipe**

The teacher/ instructor is required to direct the students to perform male threading of pipe by use of appropriate dies. They should observe safety measure in using the tools. Also wear appropriate personal protective equipments for their safety. Perform the practical stepwise as given above from 6.1.2 to 6.1.5.

#### **Activity-6.2: Practice of Internal threading of pipe**

The teacher/ instructor is required to direct the students to perform internal threading of pipe by use of appropriate taps. They should observe safety measure in using the tools. Also wear appropriate personal protective equipments for their safety. Perform the practical stepwise as given above from 6.1.2 to 6.1.5.

#### **Activity-6.3: Practice of cleaning and Lubricating Die.**

The teacher/ instructor is required to direct the students to carryout lubrication o dies during threading and perform cleaning observing OHS.

### **6.2 Perform Pipe Reaming.**

The process of removing burr after cutting and threading is known as reaming. Reamers are rotary cutting tools used in metalworking. Reaming is the process of enlarging and sizing a

hole by means of a multifluted cutting tool. Deburring is performed using a dedicated pipe reamer suitable for materials such as PVC pipes, copper, steel, and stainless steel.

### 6.2.1 Identify tools for Reaming.

A reamer is a type of rotary cutting tool used to have fare and smooth end of pipe after cutting it to desired length. Reamers can also be used to enlarge the size of holes made by drilling.

#### A- Types of Reamers

##### i- Precision reamers

These are designed to enlarge the size of a previously formed hole by a small amount but with a high degree of accuracy to leave smooth sides.

##### ii- Non-precision reamers:

These are used for more basic enlargement of holes or for removing burrs.

**The following are the main types of reamer tools:**

##### iii- Chucking Reamer (Fluted)

The chucking reamer is shown in the figure. It is also known as a machine reamer. These types of reamer consists of short parallel cutting edges with bevel lead and long body recess between shank. Cutting edges integral with a parallel or taper shank for holding the reamer. The flutes are all straight but the shank may be straight or taper.

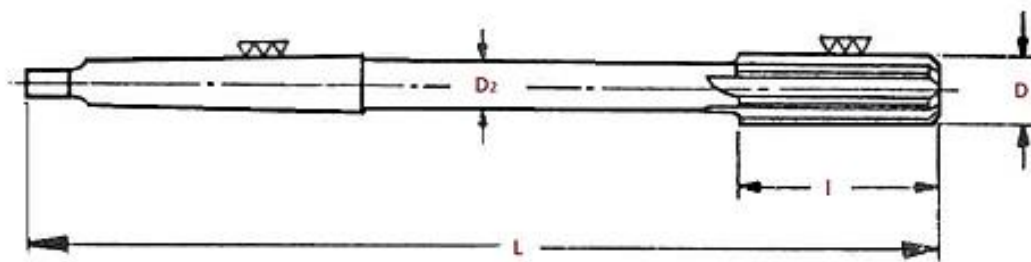

1. Length of Cutting Edge, L. Overall Length, D. Nominal Diameter, D<sub>2</sub>. Diameter of Recess

#### *Chucking Reamer with Taper or Parallel Shank (Flutes)*

The reamer is intended to be used in a drill press, turret lathe, or screw-cutting machine. It is driven at slow speed and the entire cutting is done along with the flutes. The flutes are spaced irregularly around the circumference of the body of the reamer.

##### iv- Chucking Reamer (Rose)

It differs from the fluted type in this the cutting is all done by the bevelled edges at the end. The chamfered cutting edges make an angle of 45°. The fluted body fits into the reamed hole.

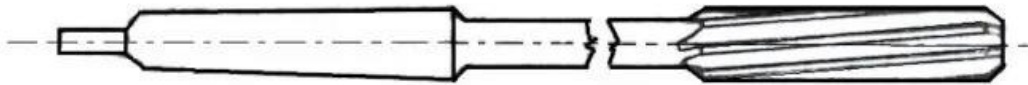

*Chucking Rose Reamer*

The body is slightly tapered, smaller towards the shank to prevent bending in the hole. This type of reamer can remove a greater amount of metal than a fluted type. A chucking rose reamer is shown in the figure above.

#### **v- Expansion Reamer**

An expansion reamer is so made that it may be adjusted by a very small amount to compensate for wear, or to accommodate some variation in hole size. As shown in the figure to effect expansion, the clamping nut is loosened and the plug is pushed inward. This causes the expansion of the blades by a small amount.

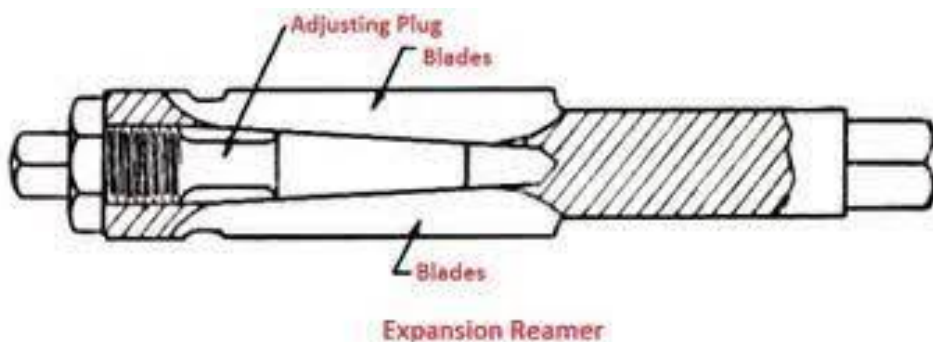

*Expansion Reamer*

### **B- Applications of Reamer**

**The followings are the applications of reamer:**

1. A reamer is a type of rotary cutting tool mostly used in metalworking.
2. A reamer is a tool used for expanding or finishing pre-drilled holes, bored, or cored to give a good finish and an exact dimension.
3. The reamer is intended to be used in a drill press, turret lathe.
4. Reamer is also used in the screw-cutting machine.

#### **6.2.2 Adopt safety measures**

The following conditions may adversely affect reamer life or in some cases damage or break the reamer. So these must be adhered to:

- Misalignment of the reamer causing a 'bell-mouth' condition and premature wear.
- Lack of correct lubrication
- Bottoming out reamer in blind holes
- Reamer chatter (synchronized vibration) caused by the below.

- Over or underfeeding the reamer
- Careless handling of the reamer

### **6.2.3 Fix work piece for reaming.**

Put on work gloves and safety glasses. Loosen the jaws of the vice by turning the handle counterclockwise just far enough to fit the work piece e between them. Place the work piece in the vice so the end you want to ream is sticking out, then turn the handle back clockwise to tighten it and secure it in place. Now that the hole is prepped, you can use your tap wrench or crescent wrench to ream the hole. You will likely have either a straight flute reamer or a left-hand spiral flute reamer, which refers to the direction of the blades that actually enlarge the hole. In the case of a spiral reamer, you will need to turn counterclockwise.

Reaming uses a pre-existing hole in the work piece and removes a small amount of material called chips. The process involves relative axial and rotational motions between the reamer and the work piece. It is often done on a drill press, but it may also be done on lathes. The work piece is held firmly in place by a vise, chuck, or fixture as the reamer is advanced into the work piece.

A typical reamer consists of a set of parallel or helical cutting edges along the length of a cylindrical body. Each cutting edge is ground at a slight angle with an undercut below the cutting edge. Reamers should only be used to remove small amounts of material to ensure a long life for the reamer and a superior finish to the hole.

### **6.2.4: Observe OHSA**

- Do not perform reaming with greasy or oily hands.
- Wear work gloves and safety glasses to protect yourself while reaming a pipe.
- If your work piece/ pipe was metal, be cautious about getting the chips on your skin as they will be sharp.

### **Activity 6.3: Practice of Reaming for different Diameter of Pipes.**

The teacher/ instructor is required to direct the students to perform reaming of different pipes by use of appropriate reamers. They should observe safety measure in using the tools. Also wear appropriate personal protective equipments for their safety. Perform the practical stepwise as given above.

### **Key Points**

53. Threading is performed with the help of dies. These can be solid stock type or of ratchet type.
54. Ratchet dies are easier to use because they allow backward stroke without rotation on pipe of chasers.
55. Dies are meant for male threading.

56. Taps are used to perform female threading. They are taper tap, bottoming tap and Plug Tap.
57. In taper type tap, the first 8 to 10 threads are tapered.
58. Only 1 to 1.5 threads will be tapered in bottoming tap.
59. Plug taps have 3-5 threads tapered.
60. It is important to select proper threading tool and fix the work piece in requisite vice.
61. A pipe reamer is a tool for removing burrs that appears when a pipe is cut. Deburring is performed using a dedicated pipe reamer suitable for materials such as PVC pipes, copper, steel, and stainless steel.
62. Precision reamers are designed to enlarge the size of a previously formed hole by a small amount but with a high degree of accuracy to leave smooth sides.
63. Non- precision reamers are used for more basic enlargement of holes or for removing burrs.
64. Personal protective Equipments are necessary to prevent from accident during use of threading and reaming.
65. Reaming uses a pre-existing hole in the work piece and removes a small amount of material called chips.
66. Wear work gloves and safety glasses to protect yourself while reaming a pipe.
67. A typical reamer consists of a set of parallel or helical cutting edges along the length of a cylindrical body.
68. Always use the instruction manual and insert the requisite size of chasers in the die stock as per instructions given in the manual.

## EXERCISE

### Multiple Choice Questions

**Q-1. Tick ( ✓ ) the correct option for the following MCQs.**

- 1- The function of cutting oil when threading a pipe is to
  - (A) Provide cooling action
  - (B) Lubricate the dies
  - (C) Help remove chips
  - (D) all of These
  
- 2- Plug tap has tapered thread:
  - (A) 8 to 10
  - (B) 3 to 5
  - (C) 1 to 1.5
  - (D) None of these
  
- 3- Threading in this type of die is easier:
  - (A) Ratchet die
  - (B) Solid stock die
  - (C) both a & b
  - (D) None of These
  
- 4- The reamer is used for:
  - (A) expanding drilled hole
  - (B) deburring
  - (C) give good finish to hole
  - (D) All of these
  
- 5- The reamer in which cutting is done by the beveled edges at the end is known as:
  - (A) Chunking fluted
  - (B) Chunking Rose
  - (C) Machine bridge
  - (D) None of these
  
- 6- Male threading is performed with the help of this:
  - (A) Die
  - (B) Taps
  - (C) reamer
  - (D) None of these
  
- 7- Most of the fittings and fixtures have this type of threading:
  - (A) male
  - (B) female
  - (C) hybrid
  - (D) None of these
  
- 8- This is occupational health and safety requirement while performing threading:
  - (A) wear overall
  - (B) work with naked eyes
  - (C) have oily hands
  - (D) None of these
  
- 9- The cleaning existing threading with the help of dies is called:



- (A) chasing (B) threading  
(C) tapping (D) None of these
- 10- The threading with the help of dies is called:
- (A) chasing (B) threading  
(C) tapping (D) None of these

**Short answer to the following questions.**

- 1- Give the use of dies in pipes.
- 2- Enlist 4 types of taps.
- 3- Write down 3 considerations kept in mind during reaming from safety point of view.
- 4- Differentiate between male and female threading.
- 5- Give the use of shell reamer.
- 6- Why male and female threading is performed?
- 7- Why for a joint the threading on one side is clockwise and on the other side is counterclockwise?
- 8- Why ratchet die is preferred over fixed stock die.
- 9- Differentiate between chasing and threading.
- 10- What are chunking fluted reamers.

**Answer the following question in detail**

6. Explain the use of ratchet dies.
7. Explain safety precautions observed while threading and reaming.
8. Explain procedure of reaming different pipes.
9. Explain types of reamers.
10. Carry on the project for making model of water supply of dead end and radial system. Perform threading, join pipes with fitting and fixtures as per drawing provided by the teacher/ instructor.

## CHAPTER 7 COMMUNICATION SKILLS



### Students' Learning Outcome

**After Studying this chapter students will be able to:**

- understand listening comprehension
- learn principles for teaching listening comprehension
- understand how to listening skill be developed
- understand starting and ending conversations
- introduce oneself and others
- greeting, praising and complimenting.
- interviewing skills
- understand skimming, scanning and guessing
- intensive and extensive reading.
- understand how to improve reading skill
- understand what is writing
- learn guided writing, free writing and creative writing.
- know kinds of writing
- understand what is effective writing
- understand the process of writing

## Communication Skills

Communication is the method by which people share their ideas, opinions and feelings. It is a two-way activity between two or more peoples. Communication skills also allow the learner to understand and be understood by others. You can listen in a proper way of someone's voice. You can read a textual material etc. There are mainly following types of communication skills:

- i- Listening Skills
- ii- Speaking skills
- iii- Reading skills
- iv- Writing Skills

### 7.1: Listening Skills

Listening is one of the most important skills you can have. How well you listen has a major impact on your job effectiveness, and on the quality of your relationships with others.

#### Definition of Listening

Listening consists of auditory discrimination, aural grammar, choosing necessary information, remembering it, and connecting it to the process between sound and form of meaning

#### 7.1.1 Understand Listening comprehension

Listening comprehension is the process of understanding the verbal and non-verbal communication. It includes knowing uttered sounds, comprehending the meaning of individual words, and understanding the syntax of sentences. Listening comprehension also refers to the understanding of what the listener has heard and his/her ability to repeat the text.

#### 7.1.2: Learn Principles for teaching listening comprehension

There are general principles for teaching listening comprehension. They are as follows:

- Listening comprehension lessons should have definite goals and they should be clearly stated.
- Listening comprehension lessons should be constructed with careful step by step planning as follows below:
  - i. What to listen for.
  - ii. Where to listen.
  - iii. When to listen.
  - iv. How to listen.
- Listening comprehension structure should demand active overt student participant. That is, the most overt student participant includes his written answer to listening

comprehension material and immediate feedback on performance helps keep learners' interest and motivation.

- Listening comprehension lessons should provide a communicative necessity for remembering to develop concentration.
- Listening comprehension lessons should emphasize conscious memory work. One of the objectives of listening is to strengthen the learners' immediate recall to increase their memory spans.
- Listening comprehension lessons should “teach” not “test”.

### **7.1.3: Development of Listening Skills**

There are four ways to develop & improve your listening skills

#### **i. Face the speaker and give them your attention**

It is difficult to talk to someone who is constantly looking around. Make sure to face the speaker, maintain eye contact, and give them your undivided attention.

#### **ii. Keep an open mind**

Do not judge or mentally criticize what the speaker is telling you. Doing so can compromise your ability to take in what is being said. Never exhibit judgmental behavior, as it compromises your effectiveness as a listener. You can evaluate what was said after the speaker is finished talking, but don't do so while you are still listening to them.

#### **iii. Active listening**

Active listening shows the speaker that you're interested and is an important business communication skill. Using active listening techniques helps to ensure that you correctly understand what is said.

Active listening techniques:

- Paraphrasing back to the speaker what was said, to show understanding
- Nonverbal cues (nodding, eye contact, etc.)
- Verbal affirmations (“I understand,” “I know,” “Thank you,” etc.)
- Demonstrating concern and establishing understanding.

#### **iv. Just listen**

Create a mental model of the information, whether it be a picture or an arrangement of abstract concepts. Listen to keywords and phrases and do not rehearse what you are going to say after the speaker is done talking.

### Activity 7.1: Listening English Documentary

The teacher/ instructor is required to arrange an English documentary and direct students to listen carefully and they will be asked question about the documentary. Sample questions be asked from the students. Students be directed listen by Paying attention, withholding judgment, reflecting, clarifying, summarizing and sharing.

## 7.2 Speaking Skills

Speaking is defined as the learner's ability to express himself/ herself orally, coherently, fluently and appropriately in a given meaningful context. Suppose you have to lead a meeting for your work team. You'll probably need to make a short presentation at the beginning of the meeting, welcoming participants and explaining the agenda. This requires effective speaking skills. As you begin the talk, explain your objectives clearly. And be sure you add energy to your delivery. If you've ever heard speakers who talk in a dull monotone, you know how boring it can sound. Speaking with energy can keep people involved and prevent them from daydreaming or even falling asleep.

### Assess your self

Ask a friend to listen to your demonstration on plumbing system and to rate you from 1 (poor) to 5 (excellent) on the following:

1. Did you speak with enthusiasm?
2. Did you raise your voice level to emphasize certain words?
3. Did you use gestures to reinforce your ideas?
4. Did you make eye contact with your listener?
5. Did you keep your listener involved?

### 7.2.1 Understand Starting and Ending conversations

Here are some introductory phrases to start a conversation and introduce yourself. Some expressions are informal (relaxed / friendly) some are formal (official / important) and some are semi-formal (between formal and informal).

A conversation is an interactive communication between two or more people where an informal exchange of ideas is expressed by spoken words. The development of conversational skills and etiquette is an important part of socialization.

When welcoming and greeting visitors / guests /customers in a business environment, you want to create a good impression that will have a long-lasting impact. Visitors come into a business environment for various reasons; they could be customers (existing or new), representatives, suppliers, business partners, people from different departments / areas / organizations, and so on.

When you meet someone for a business meeting it is standard to make light or casual conversation beforehand. This light or casual conversation is called small talk.

Before getting down to business with your visitor / guest, you should start slowly by making some small talk to show interest in your visitor/guest and make them feel comfortable.

**i. Starting a conversation:**

- Hey! What's up? (informal)
- You'll never believe this, but... (informal)
- Guess what! I've just... (informal)
- Excuse me, can I talk to you for a minute? (semi-formal)
- Hello. Would you mind if I spoke to you for a minute or two? (semi-formal)
- Sorry to interrupt, but I wonder if you could help me? (formal)

And now we'll look at some of the different ways you can end a conversation. Again, some expressions are formal, some are semi formal and some are informal.

**ii. Ending a conversation:**

- Later! (informal)
- Right, got to go! (informal)
- Must dash – see you later. (informal)
- It's been nice talking to you. Bye for now! (informal)
- It was great talking to you. (semi formal)
- Been good to meet up but I have to go. (semi formal)
- My apologies, but I'm going to have to leave now. (formal)
- It's been a pleasure to meet, and hope to meet you again soon. (formal)

## **7.2.2 Introduce oneself and others**

Knowing how to greet other professionals is how you can advance your career and make better business connections. By coming off as kind and confident, you may be more memorable to the right people.

**i- Introduce oneself**

- Only share information that is relevant to the setting you are in. For instance, with networking events keep your introduction about your professional experience.
- Although you can share about yourself, showing your interest in the other person is the polite thing to do. Ask them questions about themselves and their professional life.

- Just because you're in a professional setting doesn't mean you have to lose your personality. Combine who you are with your professional side when meeting others.
- Feeling comfortable and confident can help you make a better first impression. Dressing appropriately for the type of event you're at can give you this extra boost of self-assurance.

## **ii- Introducing others**

- Asad, please meet Hassan.
- Abid, have you met Rehman?
- I'd like you to meet Zia.
- I'd like to introduce you to Zara.
- Naghma, this is Rashida. Rashida this is Naghma.

Useful responses when introducing yourself or other people

- Nice to meet you.
- Pleased to meet you.
- Happy to meet you.
- How do you do?

## **7.2.3 Greeting, praising and complimenting.**

### ***i- Greeting***

A conventional phrase used to start a letter or conversation or otherwise to acknowledge a person's arrival or presence.

Greeting is an act of communication in which human beings intentionally make their presence known to each other, to show attention to, and to suggest a type of relationship or social status between individuals or groups of people coming in contact with each other.

While greeting customs are highly culture- and situation-specific and may change within a culture depending on social status and relationship, they exist in all known human cultures. Greetings can be expressed both audibly and physically, and often involve a combination of the two.

### ***ii- Praising***

Praising is the act of expressing commendation, admiration

If you praise someone or something, you express approval for their achievements or qualities

Praise is the act of making positive statements about a person, object or idea, either in public or privately. Praise is typically, but not exclusively, earned relative to achievement and accomplishment. Praise is often contrasted with criticism, where the latter is held to mean exclusively negative statements made about something, although this is not technically correct.

### ***iii- Complimenting***

A compliment is a polite remark that you say to someone to show that you like their appearance, appreciate their qualities, or approve of what they have done. Complimenting can be done in the following ways.

- Always compliment the positivity of others. This creates positive image in his mind about you.
- Personal traits complimenting acknowledge different qualities the person exhibits. Compliment others greatness in your speech.
- Compliment the intelligence, creativity and resourcefulness of others.
- It is often good to compliment a specific action or achievements of addressee.
- Compliment on addressee good relationships with others.
- Compliment on addressee good appearance in daily life.

## **7.2.4 Interviewing skills**

In the work world, communication skills are critical in many situations. These include going on job interviews, asking questions when you need help on an unfamiliar project, training other employees, and dealing with customers.

Job interviews occur every day. People fail to get hired because they lack effective communication skills. They simply don't know how to handle an interview.

Good interviewees will gauge the interviewers and figure out how to fit into their organization.

Some tips from career counselors and human resource managers are:

- a. Do your homework.
- b. Know your purpose.
- c. Watch your body language.
- d. Be prepared.

### ***a- Do Your Homework***

Whenever you write, it's essential to know your reader. And if you stand up and give a talk, you should always know your listeners. This rule also applies in an interview. Find out as much as you



can about the organization where you're interviewing. An interviewer will almost always ask if you know something about the company.

### ***b- Know your purpose.***

You go to a job interview to persuade a company to hire you. But you can accomplish this task only by impressing interviewers with what you can do for their organizations. In short, take the "you" approach. In other words, ask yourself, "What can I, as the interviewee, do for you, the employer?" Your purpose is to sell the employer on you.

### ***c- Watch Your Body Language***

"Some interviewees look uninterested and don't pay attention. Consistent eye contact is important." Communication is not only verbal. It also involves body language. If you don't look at an interviewer when he or she shakes your hand, you make a very poor first impression. Eye contact is also necessary during the interview. Looking at your hands, twisting your ring, or looking out the window communicates a lack of interest in the interviewer and the job.

### ***d- Be Prepared***

Always practice to get prepared for interview by rehearsal. It often helps to rehearse the interview, just as you'd rehearse a talk in front of an audience.

Have a friend play the role of the interviewer and ask the types of questions. For example, when the interviewer wants to know whether you have any questions about the job or the company, be prepared to say more. Ask about the types of projects you'll likely receive on the job or the growth potential and the opportunity to assume greater responsibilities. This shows that you've thought about the position and your own career goals.

### **Activity 7.2: Presentation**

The teacher/ instructor is required to assign a presentation to the students' groups in which speaking abilities of them are explored.

### **Activity 7.3: Group discussion**

The teacher/ instructor is required to arrange group discussion amongst group of students in which speaking abilities i.e., greeting, praising and complimenting are exhibited.

## **7.3: Reading Skills**

Reason for reading, knowledge and ability are required for reading skills.

### **7.3.1: Understand Skimming, Scanning and Guessing**

Students should more focus on skim and scan reading since it is a fact that students who can skim and scan need not have to read the text thoroughly, as they are able to judge what is defined. Moreover, these two reading techniques will save a great amount of your valuable time.

Skimming and scanning are reading strategies that utilization fast eye development and watchwords to move rapidly through content for somewhat various purposes.

Skimming is reading quickly to get an overall outline of the material. Scanning is reading quickly to discover explicit realities. While skimming mentions to you what general data is inside a segment, scanning causes you to find a specific truth. Skimming resembles swimming, and scanning is more similar to pearl plunging.

### **i- Skimming**

Skimming is another quick learning process. Skimming is the act of browsing a text to gather a basic idea about that text. For example, if you want to read an interesting article in a newspaper and do not have enough time to read more than one article, you will look at a large section of the article to decide which article you want to read.

We use skimming in seeing (reading before you read), inspecting (reading after you read), deciding the principle thought from a long determination you don't wish to read, or when attempting to discover source material for an examination paper.

Skimming can save you long periods of difficulty reading. Nonetheless, it isn't generally the most suitable approach to read. It is exceptionally helpful as a see to a more nitty-gritty reading or while auditing a choice hefty in substance. However, when you skim, you may miss significant focuses or neglect the better shadings of importance, for which quick reading or maybe even examination reading might be vital.

### **Purposes of Skimming**

- To see what is in the news on a website or on a paper
- To look through a text to decide whether you want to read it or not
- To look through the television guide/program schedule to plan your evening
- To see through a catalog to choose an offer
- To go through the options after searching something on Google

### **ii- Scanning**

Scanning means to read a particular content to gather information about a certain topic. During scanning bold/italic words, headings, dates and figures are kept in focus. Scanning is done to find a word in a dictionary, search for file in cupboards or seeing timetable etc.

Scanning, as well, utilizes keywords and organizational signals. Yet, while the objective of skimming is a bird's-eye perspective on the material, the objective of scanning is to find and dip down on specific realities.

We use scanning in research to find particular facts, to study fact-heavy topics, and to answer questions requiring factual support.

Testing will also save you valuable time if you know how to scan the text properly.

### **iii- Guessing**

Guessing is fundamental to comprehension. According to Duffy (2003), Guessing is the strategy most relied upon as we begin reading. Good readers anticipate meaning. They do this by

Guessing what they think is going to happen in the selection and by revising their predictions as they read. Students rely on previous study and experiences to make educated guesses about material to be read. The simple definition is prediction as the faculty of predicting or guessing. Guessing means making intelligent guesses about what a textbook, chapter or section contains uses only a small sample of the text.

The more the subject is known, the easier it is for the reader to make Guessing because it can relate the samples of new text to our existing knowledge.

### **7.3.2 Intensive and extensive reading.**

#### **i- Intensive Reading**

Intensive reading is done in classrooms it demands more concentration. The reader repeats the text again and again to memorize the words and their meanings. The purpose of this kind of reading is to understand the thought or idea and to create it in a new way. A student should pay more heed and attention to understand the content. Intensive reading is usually done while preparing for exams. It includes exploratory reading, critical thinking and analytical reading e.g., reading a book for exams, reading physician's prescription etc

The meaning of intensive reading is to read and learn with full concentration and focus. It's not about reading book after book or 10 articles a day. Even if you are reading a single line, you should try to understand what the words are expressing.

Intensive learning is one of the most critical skills you can develop to gain better understanding of knowledge. When you have to read a work report, for example, you can't just read it and call it a day.

#### **ii- Extensive Reading**

Extensive Reading is usually done out of the classrooms. Extensive reading is done to fulfil someone's aesthetic sense the reader reads for his own interests and information, there is no compulsion for students to do extensive reading. It is done in leisure time, e.g., reading magazine and newspaper, poetry and jokes etc.

Extensive reading is a type of reading where you engage yourself with different types of reading material. It can be fiction, non-fiction, work-related documents, newspaper articles or even statistical data.

### **7.3.3 Understand how to improve reading skill**

#### **a- Understanding**

The reader should fully understand the given material. He should keep the words and their meanings in mind. This can only be done in suitable atmosphere.

#### **b- Concentration**

With proper attention and concentration students can improve their reading skills

### **c- Critical Analysis**

Deep and critically evaluated study can provide students the right information and true facts.

### **d- Objective of Reading**

A student should always keep in mind the purpose of reading.

### **e- Central idea/theme**

While reading the reader should comprehend the theme completely. It brings expertise in reading skills

### **f- Method of reading**

While reading the reader/ student should adopt proper way of doing it. Sitting position, physical comfort ability, light, peacefulness helps in improving reading skills.

### **g- Enrichment of vocabulary**

Vocabulary helps the reader in reading while reading helps the reader in improving vocabulary. underline the important words and sentences, find out the meanings of difficult words.

### **h- Speed of reading**

The speed of reading should be moderate. The reader may not try to exceed in quantity but he should always go for the quality. All the principles play the role of auxiliary agents in reading.

### **Activity 7.4: Reading English Newspaper, Novels and Books.**

The teacher/ instructor is required to assign students to read the English newspaper, novel, books. The have to submit the summary of allocated part of newspaper, novel and book.

## **7.4: Writing Skills**

It is an act of communicating through written words. Just like when you send messages by written mode or the information written in newspaper, books etc.

### **Advantages of written communication**

- It is a permanent record
- It can be circulated easily
- Suitable for future references

### **Disadvantages of written communication**

- It takes time to write documents
- Once written it is difficult to change
- It requires good knowledge of language and grammar
- Receiver can interpret it in the wrong way

### **7.4.1 Understand what is writing**

Writing is an art of conveying one's message or thoughts in form of words, letters, symbols or sketches on paper, wood, stone, iron, skin or any other material.

"Writing" is the process of using symbols (letters of the alphabet, punctuation and spaces) to communicate thoughts and ideas in a readable form.

Generally, we write using a pen/pencil (handwriting) or a keyboard (typing). With a pen/pencil we usually write on a surface such as paper or whiteboard. A keyboard is normally attached to a typewriter, computer or mobile device. Voice recognition programs allow those who can't see or use their hands to have their thoughts transcribed.

To write clearly it is essential to understand the basic system of a language. In English this includes knowledge of grammar, punctuation and sentence structure. Vocabulary is also necessary, as is correct spelling and formatting.

### **7.4.2 Guided writing, free writing and Creative writing.**

#### **a- Guided Writing**

This stage of writing depends upon the copies of tables, dictation and exercises. There are different sub stages of guided writing including completion, reproduction, transformation, summarizing and expansion.

#### **b- Free Writing**

Free writing brings creative skills of students to light. The teacher only provides the subject or title and response. It includes paragraph writing, composition and essays.

#### **c- Creative writing**

Creative writing is any writing that falls outside of technical, journalistic, or academic writing. You can think of it as classic storytelling. Creative writing is an art of sorts - the art of making things up. It's writing done in a way that is not academic or technical but still attracts an audience.

#### **d- Controlled Writing**

Controlled Writing enables the writer to avoid mistakes in the very beginning. Teacher or guide provides learning material and language in this method.

### **7.4.3: Know Kinds of writing**

There are three kinds of writing

- i. Descriptive writing
- ii. Narrative writing
- iii. Expository writing

### **i- Descriptive Writing**

Descriptive writing explains about persons, places, scenes and things e.g., humans and animals, buildings and cities, computers and cars and weathers...summer, winter etc.

### **ii- Narrative writing**

Narrative writing speaks about event, incident or series of incidents, e.g., walk to a procession, political gathering, cricket match, earthquake, wildfire etc.

### **iii- Expository writing**

Expository writing explains, expands and analyse. It also explains ideas, facts, factors, arguments, analysis and results. Because of its broader prospects it stimulates our thoughts and ideas. It depends upon four sub types topics of real knowledge, quotations, current topics and proverbs.

#### **7.4.4: Understand What is effective writing**

Writing that hits its mark is effective writing. An effective writing has the following characteristics:

#### **Clear:**

Write in a way that people always understand what you're saying. Clear writing only has one interpretation. That's what makes it effective.

#### **i. Credible:**

You can't *make* the reader believe you. Your reader only believes you if you write credibly. Know what you're talking about. If you ramble or are dishonest, a reader will sense it immediately.

## ii. **Persuasive:**

An effective writer inspires people with words. When you write persuasively, it sparks a reaction within your reader. Again, you can't make people do anything. People are moved by effective writing themselves.

As you can see, these characteristics have little to do with grammar. An effective writer might make grammar mistakes and get away with it. We all make mistakes in daily life. And when we talk, few of us are perfect in speech.

### **7.4.5: Understand the process of writing**

Writing process means the steps and methods used to generate a finished piece of writing. These steps are usually presented in linear fashion but may naturally occur non-linearly. Generally, the writing process can be broken into three phases: prewriting, writing, and revising.

You plan the content and organization of your paper or assignment during this first phase. In the writing phase, you implement your plan—your strategy—working out the details and fine-tuning your thoughts. In the rewriting, or revising phase, you review what you have written and consider how and where your writing can be improved. The language for report writing is usually formal. The person which transmits message is known as sender.

#### **Activity- 7.5: Report writing.**

Write a report on condition of plumbing system in your school.

### **Key Points**

69. Listening consists of auditory discrimination, aural grammar, choosing necessary information, remembering it, and connecting it to the process between sound and form of meaning
70. Listening comprehension includes knowing speech sounds, comprehending the meaning of individual words, and understanding the syntax of sentences.
71. Always be attentive, give response to speaker, and active listener.
72. Listening comprehension lessons should have definite goals and they should be clearly stated.
73. speaking is defined as the learner's ability to express himself/ herself orally, coherently, fluently and appropriately in a given meaningful context.
74. Always show good gesture and adopt reasonable starting and ending conversation techniques.

75. Adopt manners of introducing yourself and others.
76. Always be prepared for the interview to answer the relevant question and have good knowledge of firm procedure for its growth.
77. Writing is an art of conveying one's message or thoughts in form of words, letters, symbols or sketches on paper, wood, stone, iron, skin or any other material.
78. The stages of writing are: guided writing, free writing, creative writing and controlled writing.
79. Kinds of writing are descriptive writing, narrative writing and expository writing.
80. An effective writing is that which is clear, credible and persuasive.
81. Writing process means the steps and methods used to generate a finished piece of writing. It comprises of three phases- prewriting, writing, and revising.
82. Writing is an art of conveying one's message or thoughts in form of words, letters, symbols or sketches on paper, wood, stone, iron, skin or any other material.
83. The person which transmits message is known as sender.
84. The language for report writing is usually formal.



## EXERCISE

### Multiple Choice Questions

**Q-1. Tick ( ✓ ) the correct option for the following MCQs.**

- 1- Which of these should be avoided for effective listening?  
A) Pre-listening analysis    B) Listening to structured talks  
C) Team listening            D) Predicting
- 2- Which of these is based of effective listening?  
a) Note taking                b) Notice writing  
c) Letter writing                d) Predicting
- 3- This is a reading strategy:  
(A) Skimming                    (B) Scanning  
(C) Guessing                    (D) All of these
- 4- This is an advantage of written communication:  
(A) permanent record        (B) circulated easily  
(C) future reference         (D) All of these
- 5- This is a phase of writing process:  
(A) prewriting                 (B) writing  
(C) revising                    (D) All of these
- 6- Reading is usually known as:  
(A) Encoding                    (B) decoding  
(C) talking                      (D) listening
- 7- Communication is usually known as non stop:  
(A) Programme                (B) Paper  
(C) Process                      (D) Plan
- 8- The Language for report writing is usually:  
  
(A) casual                        (B) formal  
(C) loose                         (D) All of these

9- While reading which of the following is required for skills:

- (A) reason for reading      (B) knowledge  
(C) ability                      (D) All of these

10- The person which transmits message is known:

- (A) driver                      (B) cleaner  
(C) sender                      (D) writer

### Short Questions

**Short answer to the following questions.**

- 1- Define communications.
- 2- Enlist communication skills.
- 3- Define skimming and scanning.
- 4- Define praising.
- 5- Give four examples of ending conversation.
- 6- Define listening comprehension.
- 7- Give four examples of starting conversation.
- 8- What is writing?
- 9- What is meant by intensive reading?
- 10- Write 2 listening skills developing ways.

### Long Questions

**Answer the following question in detail**

1. How reading skills can be improved?
2. Write note on stages of writing.
3. Explain the tips of interviewing skills.
4. How to introduce one self and others.
5. How listening skills are developed.

## **GLOSSARY**

### **Appliances**

The devices which perform specific functions are called appliances, e.g., showers, dishwasher, water meter, hot water heater, etc.

### **Appurtenances**

The different devices required for controlling the flow of water, for preventing leakage and for other purposes in the water supply system are called appurtenances. For example, valves, cocks, fire hydrants.

### **Ball valve**

A Ball valve is a quarter-turn rotary motion valve that uses a ball-shaped disk to stop or start the flow. Most ball valves are of the quick-acting type, which requires a 90° turn of the valve handle to operate the valve.

### **Bend**

Bend is a water supply system fitting having female threads on one end and male threads to join two pipes or other components usually at 90-degree angle.

### **Breathing apparatus**

For working in a place where natural free oxygen is not available in the atmosphere, breathing escape set & breathing vents are used

### **Bush**

Bush is a water supply system fitting having female threads for small dia. & male threads for larger dia. to join different diameter pipes or other components. Its size is given by two dimensions, e.g., 1/2" x 3/4" etc.

### **Butterfly valve**

A Butterfly valve is a quarter-turn rotary motion valve, that is used to stop, regulate, and start the flow. The butterfly valve has a short circular body.

### **Check valve**

The check valve prevents backflow in the piping system. Types are swing check valve, lift check valve, tilting-disc check valve, folding-disc check valve, in-line check valve and stop check valve.

## **Cocks**

Cocks regulate the flow of water between two pipes or between exit from fresh water and entry to a sanitary fixture. Stop cock, Tee stop cock, bib cock, pillar cock, etc.

## **Cross**

Cross is a water supply system fitting having female threads to join four pipes or other components usually at 90-degree angle sharply.

## **Diaphragm valve**

A diaphragm valve has a special type of shut-off valve having opening and closing member a diaphragm made of soft material. The inner cavity of the cover and the driving member are separated. Commonly used diaphragm valves are rubber-lined diaphragm valves, fluorine-lined diaphragm valves, unlined diaphragm valves, and plastic diaphragm valves.

## **Dishwasher**

An appliance designed to contain water for washing utensils and to drain spent water into the sewer system.

## **Ducting**

Pipe network in HVACR

## **Ear Protection**

These are used for the protection of ears (Hearing protection). Ear defenders, ear plugs, communications sets, noise meters, acoustic foam.

## **Elbow**

Elbow is a water supply system fitting having female threads to join two pipes or other components usually at 90-degree angle sharply.

## **Eye and face protection**

Different types of eye wears are used for protection of eyes. The safety glasses & eye shields protect eyes from light rays. Over specs prevent the eyes from harm of surrounding liquids, chemicals due flow in to eyes. Face visors, eye wear accessories, face shields, safety goggles are also used for protection of face and eyes. Face masks prevent face from dust/ virus inhaling.

## **Fall Management**

Various arrangements are made to protect from falling. These may include: fall arresters, elbow and wrist supports, safety rope climbing, safety belt, scaffold, full body belt Back supports, safety railing, etc.

## **Fire hydrant**

A fire hydrant or fire cock (archaic) is a connection point by which fire fighters can tap into a water supply. It is a component of active fire protection. Underground fire hydrants have been used in Europe and Asia since at least the 18th century. Above-ground pillar-type hydrants are a 19th-century invention.

## **Fittings**

The components of water supply which are used to connect two or more pipes, change the direction of flow, etc. are called fittings, e.g., socket, elbow, bend, union, cross, etc.

## **Flushing Cistern (FC):**

A flushing cistern includes a reservoir with an outlet opening, the opening and closing of which is controlled by a cistern bell. It is used to flush waste in WCs and urinals to sanitary pipe work. Water-closet flushing cisterns are of three main types-the valve, the siphon, pneumatic and the tipper.

## **Foot protection**

These prevent from getting foot injuries due to slippery surface, heavy falling or rolling objects, sharp piercing edges, pinch points, etc. Safety footwear, long shoes, Electrostatic Dissipative (ESD) footwear.

## **Foul Gases**

Gases produced in plumbing which have bad smell are known to be foul gases. Foul gases are required to be disposed off through vent pipe or vent shafts.

## **Fuel Gas Piping**

Fuel gas piping is the plumbing system which facilitates the supply of fuel gas for stoves geysers, lanterns and for other purposes.

## **Gate valve**

Gate valve is a linear motion valve used to start or stop fluid flow.

## **Globe valve**

Globe valve is used to stop, start, and regulate the fluid flow. Globe valve provides better shut off as compared to the gate valve and it is costlier than a gate valve.

## **Hand protection PPEs**

For the safety of hands, hand protection specific nature gloves are used, e.g., work gloves are for general work and thermal gloves are used to work with hot objects. Similarly chemical gloves are for working with chemical nature job and mechanical gloves are used mechanical nature jobs i.e., hitting hammers to the workpiece.

## **Head protection PPEs**

Specific nature head protection equipments are hard hat, bump caps, helmets, head guards & accessories. These prevent the workers from injury that may occur due to fall of anything or the fall of worker himself.

## **Hot water heater**

An appliance designed to heat the water is known as hot water heater.

## **HVACR**

It is abbreviation of Heating, Ventilating, Air Conditioning & Refrigeration

## **MEP**

It is abbreviation of Mechanical Electrical Plumbing

## **Needle valve**

Needle valves are similar to a globe valve in design with the biggest difference is the sharp needle-like disk.

## **Pinch valve**

The pinch valve is also known as a clamp valve. It is a linear motion valve. Used to start, regulate, and stop fluid flow.

## **Plug**

This fitting is made up of plastic or GI to be used for testing pipe work leakage. These do not allow the flow of water from ends of fittings.

## **Plug valve**

Plug valve is a Quarter-turn rotary motion Valve that uses a tapered or cylindrical plug to stop or start the flow.

## **Plumbing components**

The parts which are connected to plumbing pipe work are called plumbing components These are fitting/ specials, fixtures, appurtenances and appliances.

## **Plumbing Systems**

The two systems which serve the purpose for provision of fresh water for drinking, cooking foods, taking bath, washing clothes & utensils, and for other purposes and the drainage/ disposal of used waste water and foul gases are known as plumbing systems.

## **Potable Water**

The fresh water which is free from any pollution and suitable for drinking is known as potable water.

## **PPEs**

It is abbreviation of personal protective equipments. The equipments/ dresses used to protect the plumber at workplace are known as PPEs (personal protective equipments).

## **Protective clothing**

Dress worn at work place for different nature hazards. These are chemical clothing, hi-visibility clothing, Ferro-Electric (FE) clothing, weather wear, work wear, overall and dangri,

## **Reducer**

Reducer is a water supply system fitting having female threads & one end has smaller diameter to join different diameter pipes or other components. The name to the reducer is given to the fitting which it has smaller dia. For example reducing socket, reducing tee, reducing elbow. Its size is given by two dimensions, e.g., 1/2" x 3/4" etc.

## **Relief valve**

A pressure Relief valve is used to protect equipment or piping system during an overpressure event or in the event of vacuum.

## **Safety valve**

A pressure safety valve is used to protect equipment or piping system during an overpressure event or in the event of vacuum.

## **Sanitary System**

The system which serves the purpose for the drainage/ disposal of used waste water and foul gases is known as sanitary system.

## **Septic System**

The septic system is made up of components including septic tanks, drainage area for dumping the sewage and soakage pit.

## **Shower Rose**

Shower rose is a fixture which serves the purpose of taking a bath in bathroom. For cold and hot water system, shower mixer is used to mix and supply water at required temperature (not more than 38°C)

## **Showers**

An appliance designed to contain water for a person or two and to drain spent water into the sewer system.

## **Sink**

Sink is used in kitchen to wash utensils. For supply of potable water sink faucet or sink mixer is provided. For cold and hot water system, sink mixer is used to mix and supply water at required temperature (not more than 38°C)

## **Sink Mixer**

For cold and hot water system, sink mixer is used to mix and supply water at required temperature (not more than 38°C)

## **Socket**

Socket is a water supply system fitting having female threads to join two pipes or other components in a straight line.

## **Specials**

The components of sanitary which are used to connect two or more pipes, change the direction of flow, etc. are called fittings, e.g., socket, elbow, bend, union, cross, etc.

## **Tee**

Tee is a water supply system fitting having female threads to join three pipes or other components usually at 90-degree angle sharply.



## **Traps**

Traps are used to block movement of foul gases back to home with the help of water seal (barrier). Gully trap is fixed in courtyard. Floor trap in bath, P-Trap are used with Indian WC, pipe p-traps are fixed with waste pipe of sink & wash basin, S or V-Trap with English WC.

## **Union**

Union is a water supply system fitting having female threads to unite two pipes or other components in a straight line. The joint of union can be easily opened.

## **Urinal: (U)**

A urinal is a sanitary plumbing fixture for urination only used usually in public toilets for male users in Western countries (less so in Muslim countries). They are usually used in a standing position. Urinals can be with manual flushing, automatic flushing, or without flushing, as is the case for waterless urinals. They can be arranged as single sanitary fixtures (with or without privacy walls) or in a trough design without privacy walls. Urinals designed for females ("female urinals") also exist but are rare. It is possible for females to use male urinals with a female urination device. The term "urinal" may also apply to a small building or other structure containing such fixtures. It can also refer to a small container in which urine can be collected for medical analysis, or for use where access to toilet facilities is not possible, such as in small aircraft, during extended stakeouts, or for the bedridden. These may be wall type, stand type, or corner type.

## **Valves**

Valves are the mechanical devices that control the flow of water, regulate pressure, to release or admit air, prevent flow of water in opposite direction. Types are gate valve, globe valve, swing check valve, lift check valve, tilting-disc check valve, folding-disc check valve, in-line check valve, stop check valve, ball valve, pinch valve, butterfly valve, plug valve, diaphragm valve, safety valve, relief valve.

## **Vent Pipes**

Pipes used to dispose off foul gases in a building are known as vent pipe.

## **Vent Shafts**

Big size pipes to dispose off foul gases in sewerage system are known as vent shafts.

### **Wash hand basin (WB)**

Wash hand basin (WB) is used to wash hand and mouth. It is usually manufactured from China clay duly glazed. Other materials are terrazzo, stainless steel, iron duly painted etc. Needless to say, various types of basins cater to different needs. There are above counter basins, under-mount basins, compact basins, wall-hung basins, corner type basin, bowl type basin and a lot more.

### **Water closet (W.C.)**

Water closet is a sanitary fixture which disposes human excretion through sanitary system. These are of two types: i- European type, ii- Indian type

### **Water meter**

An appliance designed to measure the quantity water through the pipe is known as water meter.

### **Water Supply System**

The system which serves the purpose for provision of fresh water for drinking, cooking foods, taking bath, washing clothes & utensils, is known as water supply system.

## Answers to the Multiple-choice Questions

### Book-I, Grade IX

#### Chapter No. 1

1	A	2	A	3	C	4	B	5	C
6	C	7	A	8	A	9	D	10	A

#### Chapter No. 2

1	D	2	D	3	A	4	B	5	C
6	D	7	C	8	B	9	D	10	D

#### Chapter No. 3

1	D	2	B	3	C	4	C	5	C
6	B	7	B	8	C	9	A	10	D

#### Chapter No. 4

1	A	2	D	3	B	4	C	5	D
6	B	7	A	8	B	9	A	10	C

#### Chapter No. 5

1	B	2	A	3	D	4	C	5	D
6	D	7	A	8	D	9	B	10	A

#### Chapter No. 6

1	D	2	B	3	A	4	D	5	B
6	A	7	B	8	A	9	A	10	B

#### Chapter No. 7

1	D	2	A	3	D	4	D	5	D
6	B	7	C	8	B	9	D	10	C

## **Bibliography**

1. Plumbing Design Manual, By U.S. Department of Veterans Affairs.
2. Pipe Fitters Hand book by Anvil International
3. Plumbers Manual by Asia Society for Social Improvement & Sustainable Transformation
4. A Hand Book of PVC Pipe Design and Construction by Industrial Press New York

## About the Author



**Imtiaz Ahmad Awan** is a Senior Instructor of Civil Engineering Technology at the Punjab University of Technology Rasul (formerly the Government College of Technology Rasul), District Mandi Bahauddin. He is also performing the duty of the Director (Planning & Development) at the University. He qualified his Bachelor of Technology (Honours) in Civil (Construction) from the University of Engineering & Technology (UET) Lahore. He has been teaching Civil Technology related courses in the college to the Diploma and degree level students. He is a lead assessor for the accreditation of technical institutes. He performed key role in the development of DACUM documents (competency standards, assessment packages, curricula and training learning guides) for construction-related courses for NAVTTC and TEVTA Punjab. He is the author of books of Diploma and vocational courses for the Punjab Technical Education and Vocational Training Authority. He is the ex-Principal of Government College of Technology Pind Dadan Khan (Jhelum).

# قومی ترانہ

پاک سر زمین شاد باد! کشورِ حسین شاد باد!  
تو نشانِ عزمِ عالی شان ارضِ پاکستان  
مرکزِ یقینِ شاد باد!

پاک سر زمین کا نظام قوتِ اخوتِ عوام  
قوم، ملک، سلطنت پائندہ تابندہ باد!  
شاد باد منزلِ مراد!

پرچمِ ستارہ و ہلال رہبرِ ترقی و کمال  
ترجمانِ ماضی، شانِ حال جانِ استقبال  
سایہ خدائے ذوالجلال!



**National Vocational & Technical Training Commission (NAVTTC)**

Plot No.38, Sector H-9/4, Kirthar Road, Islamabad.

Tel: +92-51-9207518

Website: [www.navttc.gov.pk](http://www.navttc.gov.pk)